

shape CUT
YOUR
STYLE

Shower tray 150

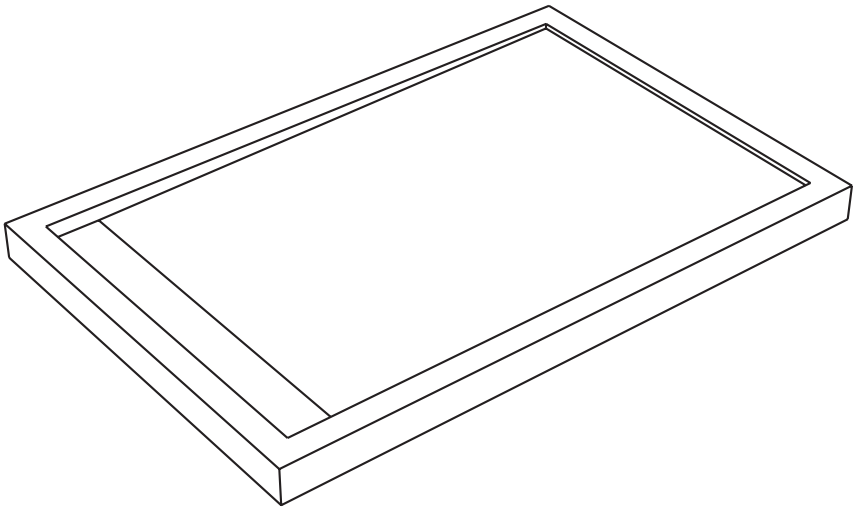

FONDOVALLE

Assembly instructions

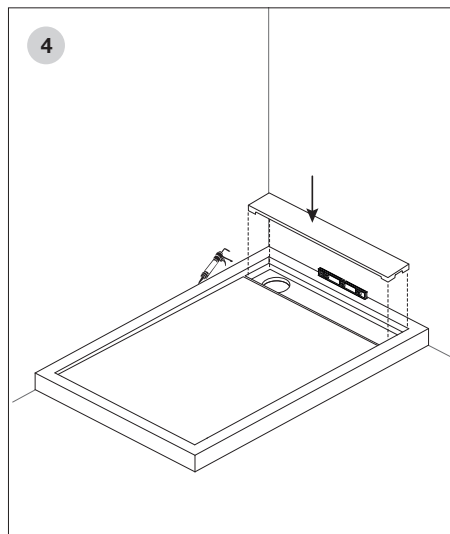
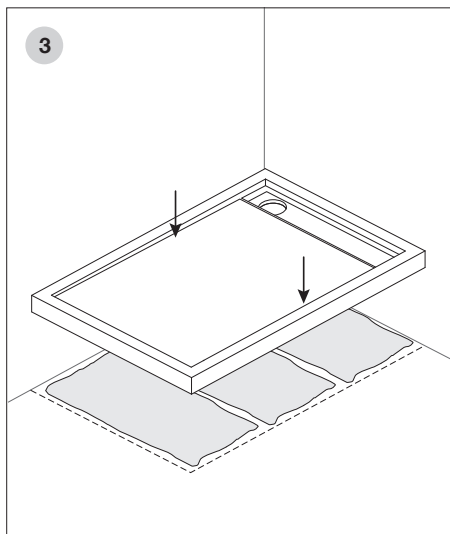
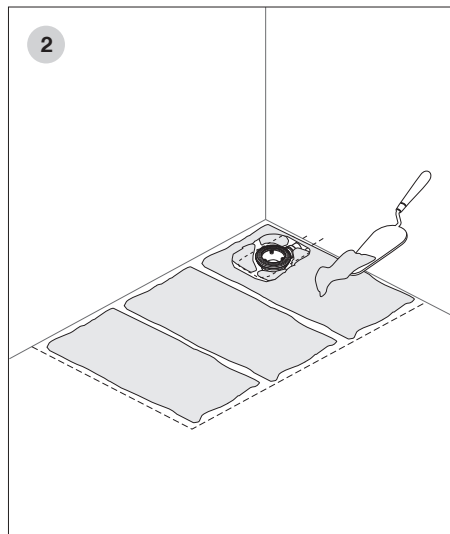
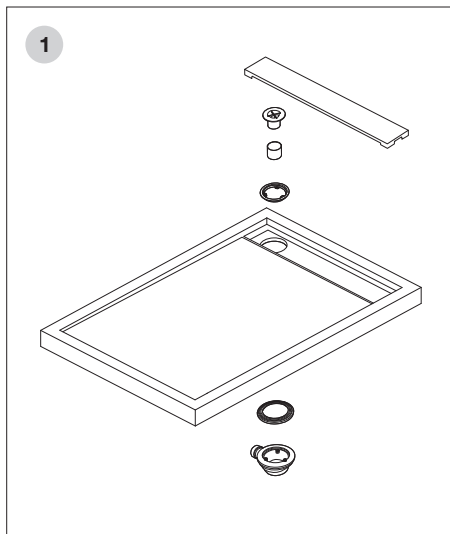

Tools needed



Pencil



Tape
measure



Spirit level



Trowel



Silicone

RECOMMENDATIONS



Use protective gloves

The simple warnings shown below ensure correct installation of the shower tray, ensuring the tray a long life and compliance with the warranty conditions.

1 Preparation

Before fitting the shower tray permanently, we recommend you fit the drain pipe into which the shower water will flow, then position the shower tray above this and check that everything fits perfectly.

Now place the tray directly on top of the drain pipe to make sure the upper drain parts fit: Only screw or fasten the cover to the shower tray once installation is complete.

2 Now prepare a lean mortar bed as a base for the shower tray.

3 Installation

Position the shower tray taking into account the thickness of the wall tiles and check it is level using a spirit level (N.B. first of all, level out the surfaces where the shower enclosure will be resting). Always keep a distance of at least 4 mm between the upper edge of the shower tray and the wall tiles.

4 Once the mortar has set, seal everything with white mould-proof silicone or elastic mortar.

Ceramic shower tray.

Type

Sloping with pop-up plug and trim base

Included

SILFRA AD 200 stainless steel drain

FAO-approved crate packaging

height: 452 mm

size: 1060X1620 mm

weight: 100 kg

Shower tray dimensions

