

**MY
TOP
FONDOVALLE**



**MY
TOP
FONDOVALLE**



General index

Indice generale
Indice général
allgemeiner Index

4	Introduction Introduzione
6	Sizes and thickness Formati e spessore
10	Applications & advantages Applicazioni e vantaggi
14	Technologies Tecnologie
22	ALL-OVER
26	Inspirations: Infinito 2.0
138	Inspirations: Different Surfaces
178	Collections 12/20 mm Collezioni 12/20 mm
324	Tech info Informazioni tecniche

Capaci di unire estetica, performance, praticità e lavorabilità le lastre ceramiche in gres porcellanato MyTop sono uno strumento duttile e completo a disposizione di designer e progettisti nel quale i ricercati design delle superfici vestono un materiale tecnologico e resistente, perfetta alternativa ai materiali tradizionali quali agglomerati plastici, pietre naturali, metalli.

La natura come ispirazione, il design come destinazione.

Inspired by nature, design oriented.
La nature comme inspiration, le design comme destination.
Die Natur als Inspiration, das Design als Ergebnis.

Able to combine aesthetics, performance, practicality and workability, the MyTop porcelain stoneware ceramic slabs are a ductile and complete tool available to designers and creators in which the sophisticated designs of surfaces are cloaked in a technological and resistant material, the perfect alternative to traditional materials such as plastic agglomerates, natural stone and metals.

Capables de conjuguer esthétique, performances, praticité et maniabilité, les dalles en grès cérame MyTop constituent un outil ductile et complet à la disposition des concepteurs et des réalisateurs de projets, dont les designs raffinés des surfaces habillent un matériau technologique et résistant, une alternative parfaite aux matériaux traditionnels tels que les agglomérés plastiques, les pierres naturelles et les métaux.

Die Natur als Inspiration, das Design als Ergebnis.
Die Keramikplatten aus Feinsteinzeug My Top sind in der Lage, Ästhetik, Leistung, praktische Eigenschaften und Bearbeitbarkeit zu vereinen und sind ein flexibles und vollständiges Hilfsmittel für Designer und Planer, bei dem die raffinierten Designs der Oberflächen ein technologisches und widerstandsfähiges Material kleiden, das die perfekte Alternative zu herkömmlichen Materialien bildet, wie Kunststoffagglomeraten, Natursteinen und Metallen.



Nate dal design per il design, le lastre MyTop sono il risultato di un processo Made in Italy che unisce alle più avanzate tecnologie produttive sapienti lavorazioni artigianali. Il risultato è una superficie sinterizzata dalle altissime prestazioni tecniche, garanzia di sicurezza e resistenza che apre nuove frontiere progettuali al mondo dell'architettura e dell'arredo. Le lastre ceramiche in gres porcellanato a 12 e 20 mm di spessore sono particolarmente indicate per top di cucine, bagni, piani di lavoro, tavoli e arredi su misura. Diventano un'alternativa eccellente ad altri materiali come marmo, granito, alluminio, grazie alla durezza, igienicità, impermeabilità del gres porcellanato. Le lastre possono essere tagliate, lavorate e forate per adattarsi a molteplici utilizzi.

Grandi formati, grandi possibilità.

Big on size, big on potential.
De grands formats, de grandes possibilités.
Große Formate, große Möglichkeiten.

12mm
1/2"

20mm
3/4"

163x324cm
64,17" x 127,56"

Born from design for design, the MyTop slabs are the result of an Italian manufacturing process that is combined with the most advanced and expert craft production technologies. The result is a sintered surface with the highest technical performance, guarantee of safety and resistance that opens up new design avenues to the world of architecture and furnishing. The porcelain stoneware ceramic slabs in the 12 and 20 mm thicknesses are particularly suitable for kitchen tops, bathrooms, work surfaces, tables and for custom furniture. They become an excellent alternative to other materials such as marble, granite and aluminium thanks to the hardness, hygiene properties and impermeability of porcelain stoneware. The slabs can be cut, worked and drilled to adapt to numerous uses.

Nées du design pour le design, les dalles MyTop sont le résultat d'un processus Made in Italy qui associe les technologies de production les plus avancées à des élaborations artisanales savantes. Le résultat est une surface frittée aux performances techniques très élevées, une garantie de sécurité et de résistance qui ouvre de nouvelles frontières de conception dans le monde de l'architecture et de la décoration. Les dalles en grès cérame de 12 et 20 mm d'épaisseur sont particulièrement indiquées pour les plans de cuisine et de salle de bains, les plans de travail, les dessus de tables et le mobilier sur mesure. Elles deviennent une excellente alternative à d'autres matériaux tels que le marbre, le granit et l'aluminium, grâce à la durabilité, à l'hygiène et à l'imperméabilité du grès cérame. Les dalles peuvent être coupées, façonnées et percées pour répondre à de nombreuses utilisations.

Entstanden aus dem Design für das Design, sind Platten My Top das Ergebnis eines Prozesses Made in Italy, der handwerkliches Können mit den fortschrittlichsten Produktionstechnologien verbindet. Das Ergebnis ist eine gesinterter Oberfläche mit sehr hoher technischer Leistungsfähigkeit, die eine Garantie für Sicherheit und Beständigkeit ist, die der Welt der Architektur und Einrichtung neue Entwurfsgrenzen eröffnet. Die Keramikplatten aus Feinsteinzeug mit einer Stärke von 12 bis 20 mm eignen sich besonders als Tops für Küchen und Bäder, Arbeitsplatten, Tische und Einrichtungsgegenstände nach Maß. Sie werden durch ihre Haltbarkeit, Hygiene, Undurchlässigkeit des Feinsteinzeugs zu einer hervorragenden Alternative zu anderen Materialien, wie Marmor, Granit, Aluminium. Die Platten können geschnitten, bearbeitet und gebohrt werden, um vielfältigen Verwendungszwecken angepasst zu werden.

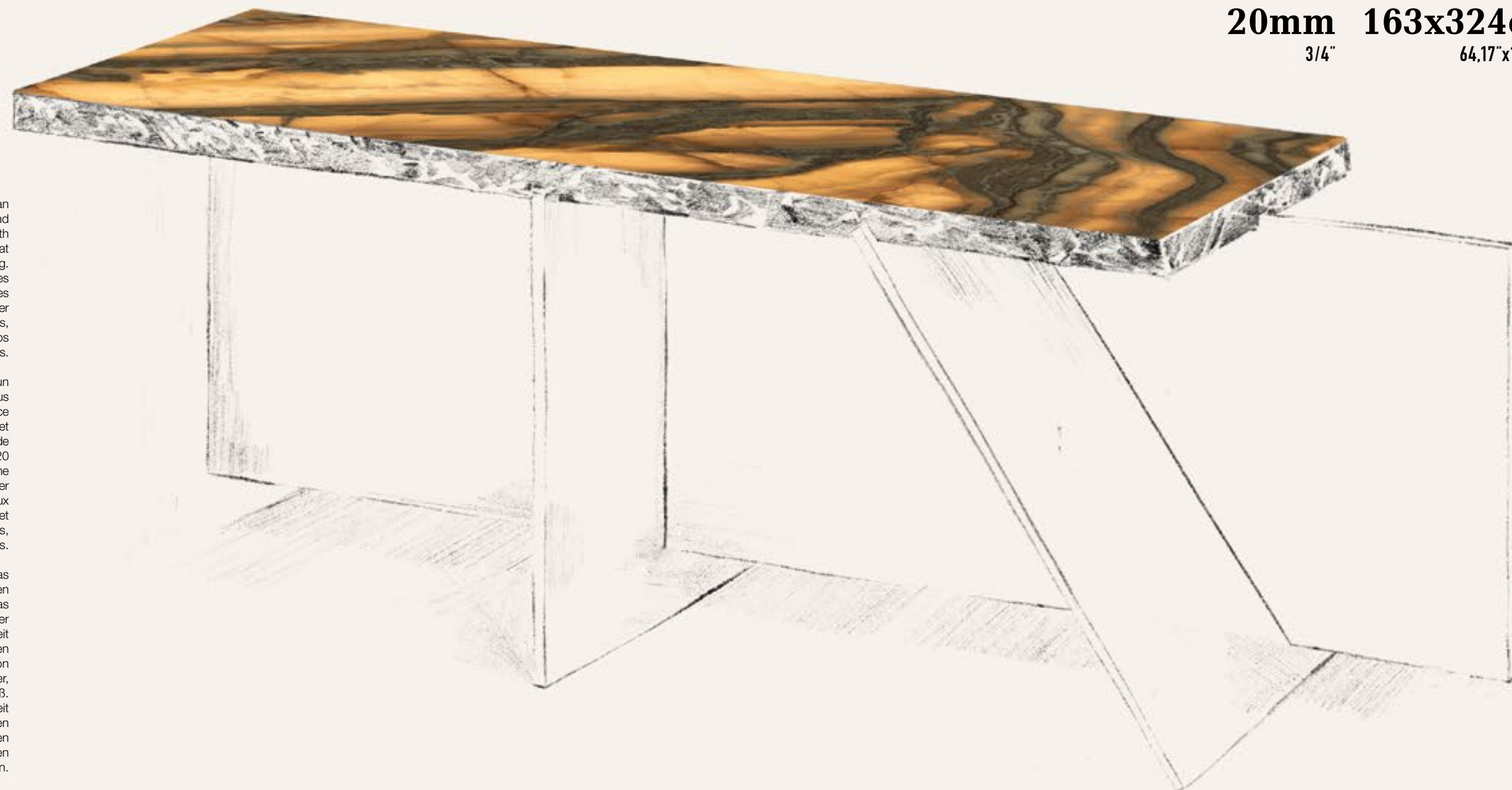



12 mm / 163x324 cm / Real Matt
Stone Lab Ceppo

FLOOR Woodblock Brave Oak 3D Texture 40x240



Igienica e adatta al contatto con gli alimenti

Hygienic and suitable for contact with food
Hygiénique et à usage alimentaire
Hygienisch und für den Kontakt mit Lebensmitteln geeignet



Perfettamente impermeabile

Totally waterproof
Parfaitement imperméable
Vollkommen undurchlässig

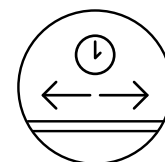

Planare e stabile nel tempo

Guaranteed flatness and stability over time
Horizontal et stable dans le temps
Dauerhaft eben und stabil

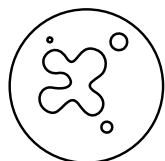

Resistente alle macchie

Stainproof
Résistante aux taches
Beständig gegenüber Flecken

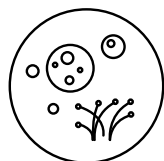

Resistente a funghi e muffe

Resistant to mould, mildew, and fungus
Résistante aux champignons et en moisissures
Beständig gegenüber Pilzen und Schimmel



Resistente a prodotti chimici, acidi, basi e solventi

Resistant to chemicals, acids, bases, and solvents
Résistante aux produits chimiques, aux acides, aux bases et aux solvants
Beständig gegenüber Chemikalien, Säuren, Basen und Lösungsmitteln

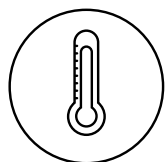

Resistente al calore e alle alte temperature

Resistant to heat and high temperatures
Résistant à la chaleur et aux hautes températures
Beständig gegenüber Wärme und hohen Temperaturen



Resistente al gelo

Frostproof
Résistante au gel
Frostbeständig

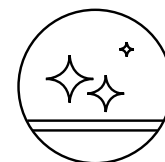

Facile da pulire

Easy to clean
Facile à nettoyer
Leicht zu reinigen

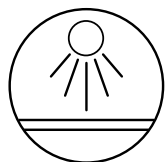

Resistente ai raggi U.V.

UV-resistant
Résistante aux rayons UV
Beständig gegenüber UV-Strahlen

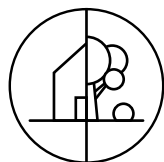

Idonea per ambienti interni ed esterni

Suitable for use indoors and out
Indiquée pour l'intérieur et l'extérieur
Geeignet für Innen- und Außenbereiche

I vantaggi di superfici eterne

The advantages of eternal surfaces
Les avantages de surfaces éternel
Die Vorteile von Oberflächen ewig

Una sofisticata naturalezza è il tratto che unisce tutte le creazioni MyTop di Fondovalle, ispirate ai marmi, al cemento, alle pietre. Texture ricercate, trattate con lavorazioni artigianali e tecnologie rare, sono alla base di una riedizione della superficie ceramica in scala più ampia, che ne mantiene il valore estetico e pratico dal fascino duraturo.

Ispirazioni materiche differenti che abbracciano le tendenze dell'interior design

Different material inspirations that embrace interior design trends.
Différentes inspirations matériériste qui épousent les tendances de la décoration intérieure.
Verschiedene Inspirationen der Materie widmen sich den Trends des Interior Designs.

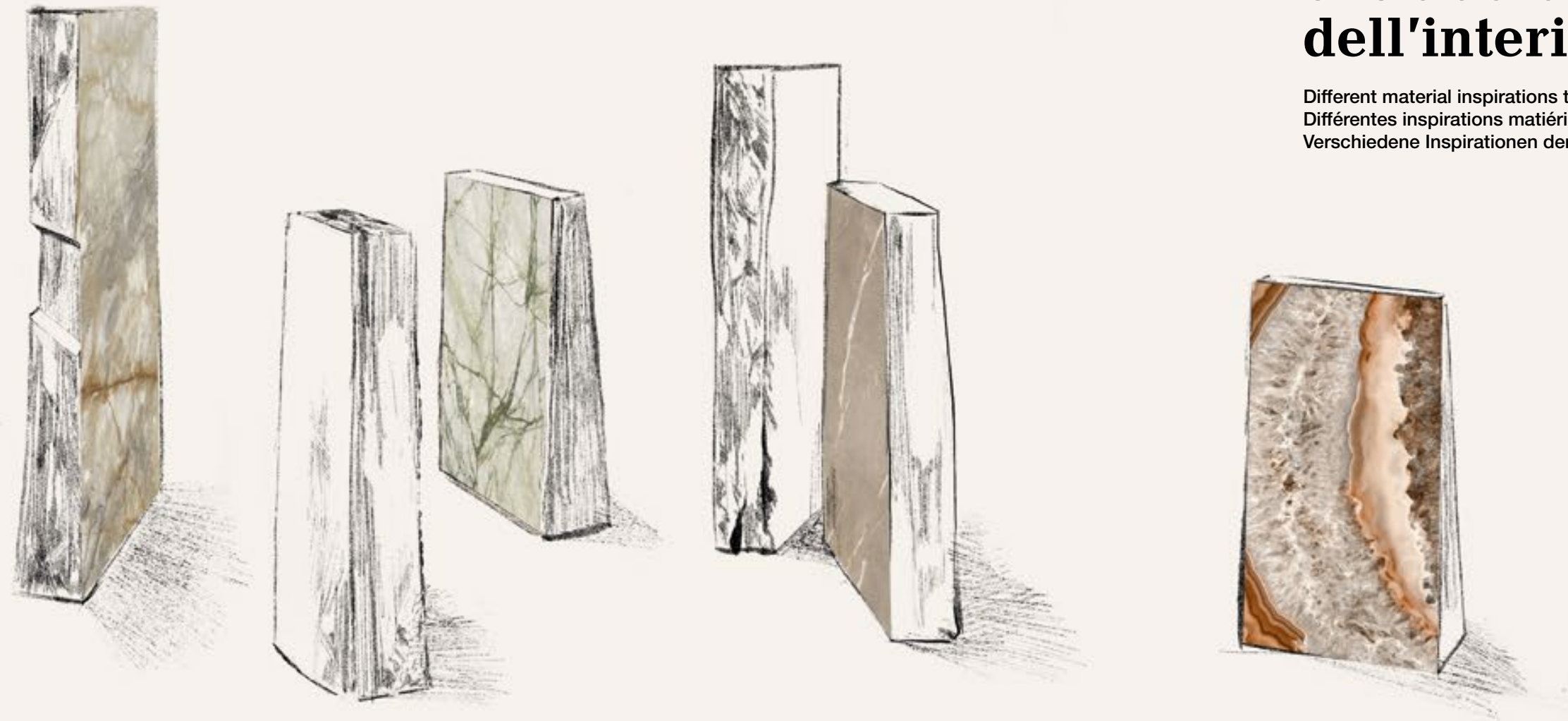

A sophisticated naturalness is the theme that unites all the MyTop creations of Fondovalle, inspired by marble, concrete and stones. Sought-after textures, processed with handcrafted workmanship and rare technologies, form the basis of a re-edition of the ceramic surface on a wider scale that preserves its aesthetic and practical value with a lasting beauty.

Un naturel sophistiqué est le trait qui unit toutes les créations MyTop de Fondovalle, inspirées du marbre, du béton, des pierres. Des textures raffinées, traitées selon des élaborations artisanales et des technologies rares, sont à la base d'une réédition de la surface céramique à plus grande échelle, qui en conserve la valeur esthétique et pratique à l'attrait durable.

Allen Kreationen MyTop von Fondovalle, die vom Marmor, vom Beton und von Naturstein inspiriert sind, zeichnen sich durch ein gemeinsames Element aus: ihre raffinierte Natürlichkeit. Die ausgesuchten, durch seltene handwerkliche Bearbeitungen und Technologien behandelten Texturen sind die Grundlage einer Neuaufgabe der keramischen Oberfläche im weiteren Sinn, die neben Reinheit und Funktionalität einen zeitlosen Charme zu bewahren vermag.



Effetto luminoso sofisticato e affascinante.

Sophisticated, enchanting luminous effect.
Effet lumineux sophistiqué et captivant.
Leuchteffekt von ausgesuchter Eleganz.

Impatto visivo scenografico

Dramatic visual impact
Impact visuel scénographique
Szenografische Wirkung

Texture grafiche che emanano luminosità

Graphic textures with a luminous radiance
Textures graphiques lumineuses
Grafische Texturen von leuchtender Ausstrahlung

Superfici con mutevoli giochi di luce

Surfaces with varying interplays of light
Surfaces avec des jeux de lumière changeants
Oberflächen mit abwechslungsreichen Lichtspielen

L'effetto ALL-LIGHT, derivante da un sofisticato sviluppo grafico, **riproduce l'effetto di una retroilluminazione naturale** e dona alla superficie un effetto luminoso raffinato e suggestivo. L'impatto visivo, elegante e moderno, è ideale per i progetti d'interior design che si propongono in modo esclusivo e scenografico.

The ALL-LIGHT effect, derived from sophisticated graphic design, **reproduces the effect of natural backlighting** and gives the surface a luminous radiance of great loveliness. Its elegant, modern appearance is ideal for striking, luxurious interior design projects.

L'effet ALL-LIGHT, issu d'un développement graphique sophistiqué, **reproduit l'effet d'un rétroéclairage naturel**, offrant à la surface une luminosité raffinée et enchanteresse. L'impact visuel, élégant et moderne, est idéal pour les projets de design intérieur qui souhaitent se présenter de manière exclusive et scénique.

Der ALL-LIGHT Effekt, dem eine aufwändige Designentwicklung zugrunde liegt, **ahmt eine natürliche Hinterleuchtung** nach und verleiht der Oberfläche eine reizvolle, leuchtende Ausstrahlung. Die elegante, moderne Optik ist ideal für Interior-Projekte, die auf eine exklusive und szenografische Wirkung setzen.





Vena passante per un'estetica in continuità.

Through-body veining for a continuous aesthetic.
Veine traversante pour une esthétique en continuité.
Durchgängige Ader für eine nahtlose Optik.

Coerenza tra superficie e impasto, anche dopo tagli e forature

Correspondence between surface and body, even after cutting and drilling
Cohérence entre la surface et la pâte, même après découpes et perçages
Visuelle Übereinstimmung von Oberfläche und Masse, auch nach Schneid- und Bohrarbeiten

Interpretazione industriale del marmo naturale

Industrial interpretation of natural marble
Interprétation industrielle du marbre naturel
Industrielle Interpretation von echtem Marmor

Versatilità e innovazione per il mondo dell'arredo

Versatility and innovation for the furnishing world
Polyvalence et innovation pour le monde de la décoration
Vielseitigkeit und Innovation für die Einrichtungswelt

La tecnologia ALL-VEIN a vena passante applicata alle grandi lastre MyTop con spessore 20mm, è frutto di un processo produttivo all'avanguardia in grado di amalgamare gli elementi dell'impasto in tutto il suo spessore e **dona continuità tra superficie e corpo della lastra**. Il risultato che ne consegue riproduce l'effetto del total body dell'ispirazione materica **anche nelle operazioni di taglio, foratura e rifinitura** spesso necessarie per realizzare gli elementi di arredo come top per la cucina, bagni, tavoli. Il prodotto finale si differenzia per la sua straordinaria coerenza visiva e funzionale nel piano e nei bordi, e per una versatilità che lo rende perfetto per soluzioni di design dall'estetica naturale e senza compromessi.

The through-body ALL-VEIN applied to MyTop large slabs in 20 mm thickness is the outcome of a leading-edge production process that amalgamates the ingredients of the tile body mix through its entire thickness and **achieves continuity between the surface and body of the slab**. The result is the accurate total-body reproduction of the effect of the inspiration material, **even in case of the cutting, drilling or trimming** often necessary to create interior design features such as kitchen and bathroom countertops and table tops. The end product is unrivalled in the amazing visual and functional continuity of its surface and edges, with a versatility that makes it perfect for design solutions of sheer natural beauty.

La technologie ALL-VEIN à veine traversante, appliquée aux grandes dalles MyTop de 20 mm d'épaisseur, est le fruit d'un procédé de pointe, capable d'amalgamer les éléments de la pâte à travers toute son épaisseur, **de sorte à créer une continuité entre la surface et le corps de la dalle**. Le résultat final reproduit l'effet du Total Body de l'inspiration matière **même lors des opérations de découpe, perçage et finitions**, souvent nécessaires pour réaliser des éléments de mobilier tels que des plans de cuisine, plans de toilette, ou tables. Le produit final se distingue par son extraordinaire cohérence visuelle et fonctionnelle tant sur la surface que sur les bords, ainsi que par sa polyvalence, qui en fait une solution design idéale pour un style naturel et sans compromis.

Die ALL-VEIN Technologie mit durchgängiger Ader wird für die 20 mm starken großformatigen Platten MyTop eingesetzt. Sie resultiert aus einem hochmodernen Produktionsverfahren, **das die Rohmassebestandteile im gesamten Korpus vermengt**, so dass Plattenoberfläche und Plattenkörper nahtlos ineinander übergehen. Daher wirkt das Produkt **auch bei den oftmals notwendigen Schneid-, Bohr- und Zurichtarbeiten** zur Anfertigung von Einrichtungselementen wie Arbeits-, Waschtisch- und Tischplatten materialecht und wie aus einem Körper geschaffen. Das Fertigerzeugnis unterscheidet sich durch die visuelle und funktionale Übereinstimmung von Fläche und Kanten und eine Vielseitigkeit, die es für Designkonzepte mit einer natürlichen, kompromisslosen Ästhetik empfiehlt.

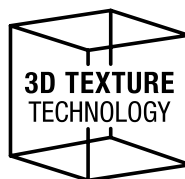

Texture 3D dall'intenso realismo materico.

3D Texture with intense material realism.

Des textures matiéristes en 3D extrêmement réalistes.

3D-Oberflächen mit unglaublich realistischer Anmutung.

Matericità tridimensionale

Three-dimensionality
Effet matière tridimensionnel
Dreidimensionales Materialbild

Profondità di dettaglio

Depth of detail
Profondeur des détails
Sorgfältig ausgearbeitete Details

Grande naturalezza e veridicità

Striking naturalness and realism
Un grand naturel et une grande véracité
Natürlichkeit und Authentizität

Fondovalle inaugura una nuova era nella produzione del gres porcellanato grazie a 3D Texture, **una tecnologia digitale altamente innovativa che regala una matericità profonda**, generando un effetto tridimensionale sulle superfici, fedele all'essenze di ispirazione. La tecnologia 3D Texture consente una perfetta sincronia tra differenti applicazioni e materie con effetti di realismo e profondità di dettaglio straordinari. Il risultato è frutto di investimenti e assidua ricerca, e arricchisce di tridimensionalità l'impasto pressato, cromie e strutture coincidono sinergicamente e le superfici acquistano un'autentica veridicità percepibile sia al tatto che alla vista.

Fondovalle is heralding a new era in the production of porcelain stoneware thanks to 3D Texture, **a highly innovative digital technology that offers a deep material quality**, producing a three-dimensional effect on surfaces to accurately resemble the wood that inspired them. 3D Texture technology permits perfect synchronisation between different applications and materials with extraordinarily realistic effects and depth of detail. The result is the fruit of investment and painstaking research, enhancing the three-dimensionality of the pressed mix; colours and textures synergistically harmonise and the surfaces acquire an authenticity perceptible to both touch and sight.

Avec Fondovalle, la production de grès cérame entre dans une nouvelle ère grâce à 3D Texture, **une technologie numérique tout à fait innovante qui apporte un rendu fortement matiériste**, en créant un effet tridimensionnel sur les surfaces, parfaitement fidèle à l'essence dont elle s'inspire. La technologie 3D Texture permet une synchronisation parfaite entre les différentes applications et matières, avec d'extraordinaires effets de réalisme et de profondeur du détail. Fruit d'un investissement et d'une recherche assidue, le résultat enrichit la pâte pressée d'un effet tridimensionnel. Les couleurs et les structures coïncident en synergie et les surfaces acquièrent une véracité authentique perceptible non seulement à la vue mais aussi au toucher.

Dank der hochinnovativen Digitaltechnik 3D Texture, **die eine besondere Materialtiefe erzeugt, eröffnet Fondovalle ein neues Kapitel in der Produktion von Feinsteinzeug**. Oberflächen mit plastischer Wirkung geben das zum Vorbild dienende Material äußerst getreu wieder. Die Technik 3D Texture ermöglicht eine vollkommen synchrone Erzeugung von Struktur und Dekor, wodurch eine ungewöhnlich realistische Wirkung und hohen Detailtiefe erzielt wird. Dank Investitionen und intensiver Forschungstätigkeit gelang es, der gepressten Masse eine besondere Tiefenoptik zu verleihen. Durch die passgenaue Übereinstimmung zwischen Farbauftrag und Struktur geben die Oberflächen haptisch wie optisch ein täuschend echtes Bild der Vorlage wieder.



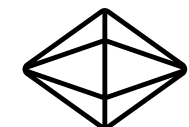

CRYSTAL
TECHNOLOGY

Preziosità infinita di brillante splendore.

Splendidly bright and infinitely precious.
Raffinement infini à l'éclatante splendeur.
Die unendliche Kostbarkeit strahlenden Glanzes.

Superfici più luminose e profonde

Brighter, deeper surfaces
Des surfaces plus lumineuses, plus profondes
Leuchtendere und plastischere Oberflächen

La tecnologia Crystal arricchisce le superfici di una particolare trasparenza e luminosità, generata da una miscela preziosa di minuscole particelle di cristalli e pigmenti perlescenti che crea infinite e mutevoli rifrazioni luminose. Le texture grafiche appaiono visibilmente più brillanti e acquisiscono profondità. Grazie a questa tecnologia le superfici presentano mutevoli effetti cangianti che variano in base alla luce, generando un effetto di prezioso splendore.

The Crystal technology enriches surfaces with a special shine and transparency, generated by a precious mix of tiny particles of crystals and pearly pigments, refracting the light in an infinity of constantly changing ways. The patterning textures acquire vastly greater brightness and depth. This technology gives surfaces iridescence that changes with the light, generating an effect of exquisite splendour.

Texture con mutevoli effetti di trasparenza

Textures with ever-changing transparency
Des textures aux effets de transparence changeants
Texturen mit facettenreichen Transparenzen

Raffinement infini à l'éclatante splendeur La technologie Crystal enrichit les surfaces d'une transparence et d'une luminosité particulières, que génère un mélange précieux de minuscules particules de cristal et de pigments nacrés, créant des réfractions lumineuses infinies et changeantes. Apparaissent visiblement plus brillantes, les textures graphiques gagnent en profondeur. Grâce à cette technologie, les surfaces présentent des effets irisés changeants, qui varient en fonction de la lumière et créent un effet de précieuse splendeur.

Riflessi di luce e ombra cangianti

Iridescent light and shade effects
Des reflets changeants d'ombre et de lumière
Changierende Licht- und Schattenspiele

Die Crystal-Technologie verleiht Oberflächen eine besondere Transparenz und Ausstrahlungskraft, die auf der kostbaren Mischung feinsten Kristallpartikel und perlmuttfarbenen schimmernder Pigmente beruhen, die einen facettenreichen Glanz erzeugen. Die grafischen Texturen treten leuchtend hervor und erhalten mehr Tiefe. Dank dieser Technologie changiert die Oberfläche je nach Einfallswinkel des Lichts in einem prachtvoll glänzenden Farbspiel.

ALL-OVER è una tecnica che permette di riportare la texture della lastra ceramica anche sul bordo, ristampata digitalmente sulla porzione di superficie selezionata, in maniera fedelissima alla grafica di partenza. Questa lavorazione è frutto di una tecnologia produttiva innovativa, concessa in esclusiva a Fondovalle e oggetto di domanda di brevetto, capace di creare un effetto materico delle superfici in gres porcellanato molto più realistico, mantenendo una continuità di texture che dal piano scende e prosegue lungo tutto lo spessore.



Una continuità estetica senza precedenti per superfici che sanno distinguersi.

Exclusive aesthetic continuity for surfaces that know how to stand out
Une continuité esthétique sans précédent pour des surfaces qui savent se démarquer
Eine bisher nie erzielte einheitliche Optik für Flächenbeläge der besonderen Art

ALL-OVER is a technique that also allows the texture of the ceramic slab to be reproduced on the edge, digitally reprinted on the selected portion of the surface in a way that is very faithful to the original graphic. This process is the result of an innovative production technology – exclusively granted to Fondovalle and the subject of a patent application – that creates a much more realistic textural effect on porcelain stoneware surfaces, maintaining a continuous texture that descends from the top and continues throughout the thickness.

ALL-OVER est une technique qui permet de reproduire la texture de la dalle céramique jusque sur le bord, en réimprimant numériquement la partie sélectionnée de la surface, dans une réplique tout à fait conforme au graphisme d'origine. Ce traitement est le résultat d'une technologie de production innovante, accordée à titre exclusif à Fondovalle et faisant l'objet d'une demande de brevet. Il permet de créer un effet de matière beaucoup plus réaliste sur les surfaces en grès cérame, en maintenant une continuité de texture qui descend du dessus pour se poursuivre sur toute l'épaisseur.

ALL-OVER ist eine Technik, die es ermöglicht, die Textur der Keramikplatte auch auf der Kante wiederzugeben. Per digitalem Druck wird also Oberflächenbild getreu auf diesem Plattenteil reproduziert. Möglich ist dies durch ein innovatives, exklusiv von Fondovalle genutztes Produktionsverfahren, das Gegenstand einer Patentanmeldung ist. Durch die von der Plattenoberseite auf die gesamte Kante übergehende Textur erhält das Feinsteinzeug eine unvergleichlich realistische Materialoptik.





ALL-OVER è stata pensata in particolar modo per rifinire tavoli e mobili della collezione Shape, ma si presta potenzialmente a valorizzare qualsiasi complemento di arredo custom-made o può essere applicata per rifinire dettagli architettonici, oggettistica e progetti di design in cui viene richiesta la massima cura del dettaglio. L'effetto di ALL-OVER ripropone ciò che avviene in natura nelle pietre naturali che si distinguono per le loro variazioni, soprattutto se si considera la superficie orizzontale della lastra rispetto alla costa dove la vena è tagliata trasversalmente ed è quindi, a volte, diversa.



Infinite applicazioni in ambito residenziale e commerciale.

Infinite applications in residential and commercial locations
Une infinité d'applications en résidentiel et en commercial
Mannigfaltige Anwendungsmöglichkeiten
im Wohn- und Objektbereich

Kitchen Top
Top Cucina

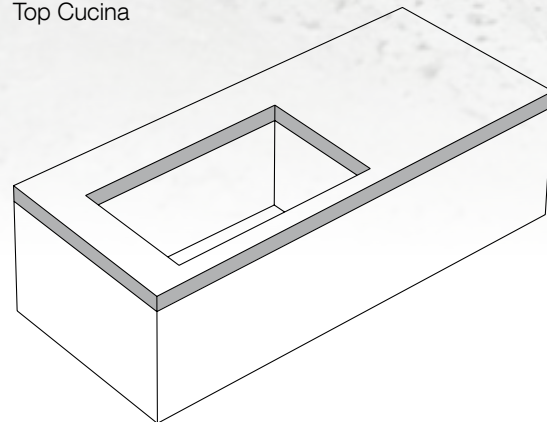

Shelves and furniture
Mensole e mobili

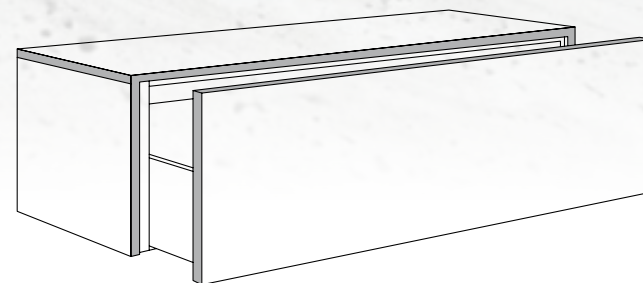

Bathrooms Top
Top bagni

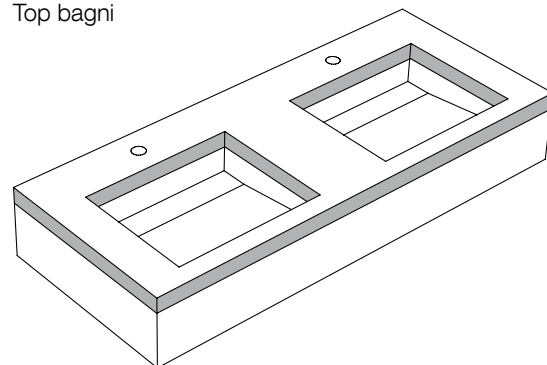

Tables
Tavoli

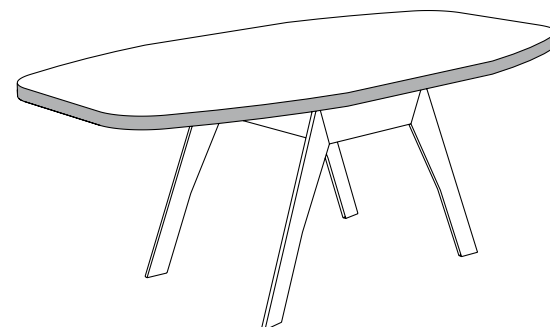

Porcelain stoneware slabs
Lastre in gres porcellanato
Grès cérame plaques
Feinsteinzeugs platten
6 mm / 8,5 mm / 12 mm / 20 mm

ALL-OVER has been especially designed to finish tables and furniture from the Shape collection, but it can potentially be used to enhance any custom-made furniture accessory or applied to finish architectural details, objects and design projects that require the utmost attention to detail. The All-Over look accurately reproduces the effects that occur in the environment with natural stones and their rich variations, especially between the horizontal surfaces of slabs and the edges, which cut through the veining, meaning that the patterning is sometimes different.

ALL-OVER a été spécialement conçue pour la finition des tables et des meubles de la collection Shape, mais elle peut être utilisée pour valoriser n'importe quel élément de décoration sur mesure ou pour la finition de détails architecturaux, d'objets et de projets de design où il est fondamental d'apporter le plus grand soin aux moindres détails. L'effet All-Over reproduit la création de la nature sur les pierres naturelles : des variations typiques, notamment sur la surface horizontale de la dalle par rapport à la tranche, où, du fait de la coupe transversale, la veine est parfois différente.

ALL-OVER wurde speziell für die saubere Ausführung der Tische und Möbel der Kollektion Shape konzipiert, kann sich jedoch auch für die Gestaltung maßgefertigter Einrichtungs-elemente, Detaillösungen und Wohnaccessoires sowie für die Umsetzung von Designprojekten verwendet werden, bei denen es auf fein ausgearbeitete Details ankommt. All-Over bringt Naturstein in seinem ganzen Facettenreichtum zur Geltung, und zwar in der Fortsetzung des Materialbildes der horizontalen Oberfläche auf der Kantenfläche der keramischen Platte, wo die Äderung eine andere Schnittfläche und deshalb bisweilen eine andere Gestalt aufweist.

INSPIRATIONS: INFINITO 2.0

ISPIRAZIONI: INFINITO 2.0

La collezione Infinito 2.0 raccoglie una ricercata selezione di marmi naturali, trasformati in sorprendenti superfici in gres porcellanato dalle potenziate qualità tecniche ed estetiche. Continuità di toni, venature calibrate, finiture lucide e opache trasformano la materia “marmo” in un prodotto versatile, capace di incontrare le rinnovate esigenze della progettazione contemporanea.

The Infinito 2.0 collection brings together a stylish assortment of natural marbles, recreated in stunning porcelain stoneware offering enhanced technical and aesthetic features. Continuity of tones, balanced veining, glossy and matt finishes, turn “marble” into a versatile product that meets the ever-changing needs of contemporary design. This faithful reproduction of the most prized varieties of marble lends a unique appeal to any setting.

La collection Infinito 2.0 réunit une sélection raffinée de marbres naturels, transformés en surprenantes surfaces de grès cérame avec des qualités techniques esthétiques améliorées. La continuité des tons, les veines calibrées, les finitions brillantes et mates transforment la matière « marbre » en un produit polyvalent, capable de répondre aux exigences renouvelées de la conception contemporaine.

Die Kollektion Infinito 2.0 umfasst eine auserlesene Auswahl von natürlichen Marmoren, die in überraschende Oberflächen aus Feinsteinzeug mit verbesserten technischen und ästhetischen Eigenschaften umgewandelt wurden. Kontinuität der Farbtöne, kalibrierte Aderungen, glänzende und matte Oberflächen machen die Materie “Marmor” zu einem vielseitigen Produkt, das in der Lage ist, die neuen Erfordernisse des modernen Entwurfs zu erfüllen.

Infinito 2.0

p.29

Tiger

p.32

Starlit

p.35

Labradorite Royale

p.38

Calacatta Paris

p.42

Meteor

p.47

Thassos

p.48

Statuarietto/Black Pearl

p.50

Calacatta Macchia Vecchia

p.53

Cream Diamonds

p.56

Cliff White

p.61

Golden Spider

p.64

Luxury Gold

p.68

Breccia Van Gogh

p.72

Taj Mahal

p.75

Patagonia

p.76

Fior di Bosco

p.81

Royal Creamy

p.82

Gold River

p.85

Rosso Lepanto

p.86

Calacatta Viola

p.90

Capraia

p.92

Calacatta Light

p.96

Calacatta White

p.101

Statuario Extra

p.104

Elegant White

p.107

Calacatta Gold

p.108

Green Denis

p.111

Calacatta Green

p.112

River Jade

p.116

Amazzonite

p.118

Blue Roma

p.121

Emerald Green

p.123

Agate Crystal Jade

p.126

Agate Crystal Lace

p.129

Agate Blue Velvet

p.132

Port Laurent

p.135

Pietra Grey

p.136

Sahara Noir

Infinito 2.0 Tiger

Venature marcate e colori caldi, creano un pattern che emana luce di grande impatto estetico.
Bold veining and warm shades create a stunning pattern that radiates light.
Des veines marquées et des couleurs chaudes créent un motif qui dégage une lumière d'un grand impact esthétique.
Ausgeprägte Aderungen und warme Farben erzeugen ein Muster, das Licht von großer ästhetischer Wirkung ausstrahlt.

**12 mm
163x324 cm**

**Available Finishes:
ALL-LIGHT Polished**

12 mm / 163x324 cm / ALL-LIGHT Polished

Infinito 2.0 Tiger

WALL Woodblock Brave Stripy Oak 120x278



12 mm / 163x324 cm / ALL-LIGHT Polished
Infinito 2.0 Tiger

FLOOR Portland Jordan 120x120
WALL Woodblock Brave Stripy Oak 120x278

MEETING ROOM
LOBBY



Infinito 2.0 Starlit

**Sfumature marmoree sui toni caldi
che ricordano superfici retroilluminate.**

Marble-like shading in warm tones that
create a seemingly backlit effect.

Des nuances de marbre dans des tons chauds
qui rappellent les surfaces rétro-éclairées.

Nuancen des Marmors in warmen Tönen,
die an hinterleuchtete Oberflächen erinnern.

**12 mm
163x324 cm**

**Available Finishes:
ALL-LIGHT Polished**



12 mm / 163x324 cm / ALL-LIGHT Polished

Infinito 2.0 Starlit

FLOOR Pigmento Oro 120x120

Infinito 2.0 Labradorite Royale

**Tonalità scure dal blu al grigio, con venature
chiare che creano un contrasto tridimensionale.**
Dark tones ranging from blue to grey, featuring
pale veining that creates a textured contrast.
Des nuances sombres du bleu au gris, et des
veines claires qui créent un contraste tridimensionnel.
Dunkle Farbtöne von Blau bis Grau, mit hellen
Aderungen, die einen dreidimensionalen Kontrast erzeugen.

**12 mm
163x324 cm**

**Available Finishes:
ALL-LIGHT Polished**

12 mm / 163x324 cm / ALL-LIGHT Polished
Infinito 2.0 Labradorite Royale



12 mm / 163x324 cm / ALL-LIGHT Polished
Infinito 2.0 Labradorite Royale
FLOOR Komi Elegant 40x240

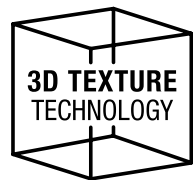

Infinito 2.0 Calacatta Paris

Un marmo chiaro su cui si intrecciano vene scure a contrasto, per delicati motivi a macchia.

A pale marble featuring contrasting dark veins, intertwined to form a gently dappled effect.

Un marbre clair sur lequel s'entrelacent des veines sombres contrastées, formant de délicats motifs mouchetés.

Ein heller Marmor, auf dem sich kontrastierende dunkle Adern verflechten, um zarte Fleckenmotive zu erzeugen.

**12 mm
163x324 cm**

**Available Finishes:
Full 3D Texture
Polished**



12 mm / 163x324 cm / Full 3D Texture
Infinito 2.0 Calacatta Paris



12 mm / 163x324 cm / Full 3D Texture
Infinito 2.0 Calacatta Paris

FLOOR Woodblock Balance Oak 40x240 - 24x240

Infinito 2.0 Meteor

Superfici eteree e cristalline vibrano alla luce.
Ethereal, shimmering crystalline surfaces.
Des surfaces éthérées et cristallines vibrent à la lumière.
Ätherische, kristalline Oberflächen schimmern im Licht.

12 mm
163x324 cm

Available Finishes:
Crystal Polished



12 mm / 163x324 cm / Crystal Polished
Infinito 2.0 Meteor / Portland Jordan

FLOOR Alpine Light Grey Cross 120x120



12 mm / 163x324 cm / Crystal Polished
Infinito 2.0 Meteor / Portland Jordan
FLOOR Alpine Light Grey Cross 120x120

Infinito 2.0 Thassos

Superfici bianco candido arricchite da particelle di cristalli e pigmenti perlescenti.
Pure white surfaces enhanced with crystalline flecks and pearly pigments.
Des surfaces blanc pâle enrichies de particules de cristaux et de pigments nacrés.
Reinweiße Oberflächen, angereichert mit Kristallpartikeln und Perlglanzpigmenten.

**12 mm
163x324 cm**

**Available Finishes:
Crystal Polished**

12 mm / 163x324 cm / Crystal Polished
Infinito 2.0 Thassos

WALL Dream Fresco 60x120
FLOOR Res Art Ash 120x120

Infinito 2.0 Statuarietto/Black Pearl

Sottili venature che si diramano eleganti su sfondi candidi e scuri.
Thin veins extend elegantly over bright white and dark backgrounds.
Des veines fines qui se ramifient élégamment sur des fonds blancs et sombres.
Dünne Aderungen, die sich elegant auf hellem und dunklem Hintergrund verzweigen.



12 mm / 163x324 cm / Natural
Infinito 2.0 Statuarietto
WALL Alpine Pine Vein 3D Texture 120x278

12 mm
163x324 cm

Available Finishes:
Natural



12 mm / 163x324 cm / Natural
Infinito 2.0 Black Pearl
FLOOR Woodblock Brave Oak 20x40

Infinito 2.0 Calacatta Macchia Vecchia

Accenti di colore beige e bruno si trasformano in sofisticate trame.
Hints of beige and brown morph into stylish textures.
Des accents beiges et bruns se transforment en trames sophistiquées.
Beige und braune Farbakzente verwandeln sich in raffinierte Texturen.

12 mm
163x324 cm

Available Finishes:
Polished



12 mm / 163x324 cm / Polished
Infinito 2.0 Calacatta Macchia Vecchia

FLOOR Homescape Sugar 120x120
WALL Homescape Sugar Tub 60x120

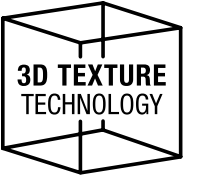

Infinito 2.0 Cream Diamonds

Profondità estetica senza precedenti, dal fascino morbido e avvolgente.
Unparalleled visual depth and a gentle, captivating beauty.
Une profondeur esthétique sans précédent, au charme doux et enveloppant.
Eine völlig neue ästhetische Tiefe, mit einem weichen und umhüllenden Charme.

12 mm
163x324 cm

Available Finishes:
Full 3D Texture Polished
Full 3D Texture

12 mm / 163x324 cm / Full 3D Texture
Infinito 2.0 Cream Diamonds

WALL Woodblock Balance Oak 24x240



12 mm / 163x324 cm / Full 3D Texture
Infinito 2.0 Cream Diamonds
WALL Woodblock Balance Oak 24x240

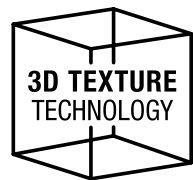

Infinito 2.0 Cliff White

Venature decise e vibranti dal forte impatto cromatico.
Bold, vibrant veining with a striking colour impact.
Des veines prononcées et vibrantes avec un fort impact chromatique.
Starke und lebendige Aderungen mit starker chromatischer Wirkung.

**12 mm
163x324 cm**

**Available Finishes:
Full 3D Texture**



12 mm / 163x324 cm / Full 3D Texture
Infinito 2.0 Cliff White



12 mm / 163x324 cm / Full 3D Texture
Infinito 2.0 Cliff White

FLOOR Homescape Sugar 120x120
WALL Homescape Sugar Tub 60x120

12 mm / 163x324 cm / Polished
Infinito 2.0 Golden Spider



Infinito 2.0 Golden Spider

Luminosità unica su fondo bianco con sottili venature rosate.
Unique brightness radiating from pink gossamer-like
veining against a white background.
Une luminosité unique sur fond blanc avec de fines veines roses.
Einzigartige Helligkeit auf weißem Untergrund
mit dünnen rosafarbenen Aderungen.

**12 mm
163x324 cm**

**Available Finishes:
Polished**



12 mm / 163x324 cm / Polished
Infinito 2.0 Golden Spider
FLOOR Komi Elegant 24x240

Infinito 2.0 Luxury Gold

Nuance dorate con striature a contrasto.
Golden shades with contrasting streaks.
Des nuances dorées avec des stries contrastées.
Goldene Nuancen mit kontrastierenden Streifen.

12 mm
163x324 cm

Available Finishes:
Polished



12 mm / 163x324 cm / Polished
Infinito 2.0 Luxury Gold
FLOOR Woodblock Balance Oak 40x240



12 mm / 163x324 cm / Polished
Infinito 2.0 Luxury Gold

Infinito 2.0 Breccia Van Gogh

Estetica sofisticata, colori neutri tra ocre e terre.
A sophisticated aesthetic featuring neutral colours in ochre and earthy tones.
Une esthétique sophistiquée, des couleurs neutres entre ocre et terres.
Raffinierte Ästhetik, neutrale Farben zwischen Ocker und Erde.

**12 mm
163x324 cm**

**Available Finishes:
Polished**



12 mm / 163x324 cm / Polished
Infinito 2.0 Breccia Van Gogh



12 mm / 163x324 cm / Polished
Infinito 2.0 Breccia Van Gogh
FLOOR Homescape Caramel 120x120

Infinito 2.0 Taj Mahal

Venature e nuvolature sfumano in un elegante unicum senza tempo.
Veining and clouding merge within this unique option with timeless elegance.
Les veines et les taches s'estompent dans un unicum élégant et intemporel.
Aderungen und Wolken verschmelzen zu einem eleganten, zeitlosen Unikat.

**12 mm
163x324 cm**

**Available Finishes:
Polished**



**12 mm / 163x324 cm / Polished
Infinito 2.0 Taj Mahal**



Infinito 2.0 Patagonia

La pregiata naturalezza di un marmo ricercato.
The natural prestige of a sophisticated marble.
Le naturel précieux d'un marbre raffiné.
Die kostbare Natürlichkeit eines edlen Marmors.

12 mm
163x324 cm

Available Finishes:
Polished
Natural

12 mm / 163x324 cm / Polished
Infinito 2.0 Patagonia

Infinito 2.0 Fior Di Bosco

Superficie calda, ispirata a un marmo italiano con venature preziose.
An inviting material inspired by an Italian marble with exquisite veining.
Une surface chaude, inspirée d'un marbre italien avec des veines précieuses.
Warme Oberfläche, inspiriert von einem italienischen Marmor mit kostbaren Aderungen.

**12 mm
163x324 cm**

**Available Finishes:
Polished
Honed**



12 mm / 163x324 cm / Polished
Infinito 2.0 Fior di Bosco



12 mm / 163x324 cm / Polished
Infinito 2.0 Fior Di Bosco



Infinito 2.0 Royal Creamy

Venature chiare su un fondo caldo e leggermente mosso, dal contrasto elegante e raffinato.
Pale veining set against an inviting, softly undulating background creates a stylish, elegant contrast.
Des veines claires sur un fond chaud et légèrement ondulé, au contraste élégant et raffiné.
Helle Aderungen auf einem warmen und leicht bewegten Hintergrund, mit einem eleganten und raffinierten Kontrast.

**12 mm
163x324 cm**

**Available Finishes:
Natural**

12 mm / 163x324 cm / Natural
Infinito 2.0 Royal Creamy

FLOOR Dream Snow 120x278
WALL Dream Camellia 120x278

Infinito 2.0 Gold River

Vene dal bronzo al bordeaux creano una trama ricca e profonda, con riflessi brillanti.
Veining ranging from bronze to burgundy in tone creates a rich texture with glimmering reflections.
Des veines allant du bronze au bordeaux créent une trame riche et profonde, avec des reflets brillants.
Adern von Bronze bis Burgunderrot erzeugen eine reichhaltige und tiefe Textur mit brillanten Reflexen.

**12 mm
163x324 cm**

**Available Finishes:
Polished**



12 mm / 163x324 cm / Polished
Infinito 2.0 Gold River

WALL Brit Tobacco 6x24,6



Infinito 2.0 Rosso Lepanto

Eleganza classica e giochi visivi in continuo mutamento.
Classic elegance and constantly changing visual effects.
Une élégance classique et des jeux visuels sans cesse renouvelés.
Klassische Eleganz und sich ständig verändernde visuelle Spiele.

**12 mm
163x324 cm**

**Available Finishes:
Polished**

12 mm / 163x324 cm / Polished
Infinito 2.0 Rosso Lepanto

FLOOR Portland Hood 120x120
WALL Res Art Pottery Mosaico Ball 30x30

Infinito 2.0 Calacatta Viola

Venature violacee accentuate dalla lucentezza della superficie polished.
Purple veining accentuated by a glossy polished surface.
Des veines violettes accentuées par la brillance de la surface polished.
Violette Aderungen, die durch den Glanz der polierten Oberfläche akzentuiert werden.

**12 mm
163x324 cm**

**Available Finishes:
Polished**



12 mm / 163x324 cm / Polished
Infinito 2.0 Calacatta Viola
WALL Komi Elegant Lodge 120x278

< Lounge
< Terrace
< Spa

12 mm / 163x324 cm / Polished
Infinito 2.0 Calacatta Viola

FLOOR Pigmento Carbone 120x120
WALL Komi Elegant Lodge 120x278



Infinito 2.0 Capraia

Effetto marmo bianco con striature grigie, viola e verde, dalla ricca versatilità decorativa.
 White marble effect featuring grey, purple, and green streaks and offering great decorative versatility.
 L'effet marbre blanc avec des stries grises, violettes et vertes, avec une riche polyvalence décorative.
 Weißer Marmor-Effekt mit grauen, violetten und grünen Streifen, mit reicher dekorativer Vielseitigkeit.

12 mm
163x324 cm

Available Finishes:
Polished
Honed
Natural



12 mm / 163x324 cm / Polished
Infinito 2.0 Capraia
 FLOOR Komi Natural 40x240

Infinito 2.0 Calacatta Light

Striature grigie su bianco creano un volume scultoreo d'impatto.
Grey streaks against a white background form a striking sculptural presence.
Des stries grises sur fond blanc créent un volume sculptural impressionnant.
Graue Streifen auf Weiß erzeugen ein wirkungsvolles skulpturales Volumen.

12/20 mm
163x324 cm

Available Finishes:
Polished
Honed
Natural



12 mm / 163x324 cm / Polished
Infinito 2.0 Calacatta Light

12 mm / 163x324 cm / Polished
Infinito 2.0 Calacatta Light
FLOOR Shards Black Large Polished 120x120



Infinito 2.0 Calacatta White

Un'icona di raffinatezza dalla bellezza cristallina ed eleganti venature.
A symbol of sophistication, featuring crystalline allure and elegant veining.
Une icône de raffinement à la beauté cristalline et aux veines élégantes.
Eine Ikone der Raffinesse mit kristalliner Schönheit und eleganten Aderungen.



**12 mm
163x324 cm**

**Available Finishes:
Polished
Honed**



12 mm / 163x324 cm / Polished
Infinito 2.0 Calacatta White



12 mm / 163x324 cm / Polished
Infinito 2.0 Calacatta White



Infinito 2.0 Statuario Extra

Una superficie luminosa e versatile offre bellezza e funzionalità per il mondo dell'arredo.

A radiant, versatile surface offering beauty and functionality for the world of furnishings.
Une surface lumineuse et polyvalente offre beauté et fonctionnalité pour le monde de la décoration.
Eine helle und vielseitige Oberfläche bietet Schönheit und Funktionalität für die Welt der Einrichtung.

**12/20 mm
163x324 cm**

Available Finishes:

**Polished
Honed
Natural**

**Polished - ALL-VEIN
Natural - ALL-VEIN**

Tecnologia con vena passante.
Technology for full-body veining.
Technologie avec veinage traversant.
Technologie mit durchgehender Ader.

12 mm / 163x324 cm / Polished

Infinito 2.0 Statuario Extra

FLOOR Shards Black Large Polished 120x120



12 mm / 163x324 cm / Polished
Infinito 2.0 Statuario Extra

Infinito 2.0 Elegant White

Leggerezza e luminosità, con delicati movimenti neutri su fondo bianco.
Lightness, brightness, and subtle neutral patterns against a white background.
Légèreté et luminosité, avec de délicats mouvements neutres sur fond blanc.
Leichtigkeit und Leuchtkraft, mit zarten neutralen Bewegungen auf weißem Hintergrund.

12 mm
163x324 cm

Available Finishes:
Natural



12 mm / 163x324 cm / Natural
Infinito 2.0 Elegant White

FLOOR Background Cloud 120x120
WALL Background Cloud 120x278 / Cloud Line 60x120



Infinito 2.0 Calacatta Gold



Fondo bianco latte con sfumature grigie e striature dorate che brillano alla luce.
A milky white background featuring shades of greige set off by resplendent streaks of gold.
Fond blanc laiteux avec des nuances grêges et des stries dorées qui étincellent à la lumière.
Milchig-weißer Hintergrund mit beige-grauen Tönen und goldenen Streifen, die im Licht funkeln.

**12/20 mm
163x324 cm**

Available Finishes:

**Polished
Honed
Natural**

**Polished - ALL-VEIN
Natural - ALL-VEIN**

Tecnologia con vena passante.
Technology for full-body veining.
Technologie avec veinage traversant.
Technologie mit durchgehender Ader.



12 mm / 163x324 cm / Polished
Infinito 2.0 Calacatta Gold

Infinito 2.0 Green Denis

Il mosaico di verdi con accenti chiari è esaltato dalla superficie lucida.

A mosaic of greens enhanced with pale accents, set off by a glossy surface.

La mosaïque de verts aux accents clairs est rehaussée par la surface brillante.

Das Mosaik aus Grüntönen mit hellen Akzenten wird durch die glänzende Oberfläche hervorgehoben.

**12 mm
163x324 cm**

**Available Finishes:
Polished**



**12 mm / 163x324 cm / Polished
Infinito 2.0 Green Denis**

FLOOR Background Snowy 60x120
WALL Background Snowy 120x278 / Snowy Line 60x120



Infinito 2.0 Calacatta Green

Grafica in avorio, greige e verde con movimenti delicati e nuvole leggere.

Ivory, greige, and green patterns featuring delicate flowing and cloudlike forms.

Un graphisme ivoire, grège et vert avec des mouvements délicats et des nuages légers.

Elfenbeinfarbene, beige-graue und grüne Grafiken mit sanften Bewegungen und leichten Wolken.

**12 mm
163x324 cm**

**Available Finishes:
Polished**

12 mm / 163x324 cm / Polished
Infinito 2.0 Calacatta Green

FLOOR Komi Elegant 40x240

Infinito 2.0 River Jade

Estetica ricca con striature oblique in toni di verde, grigio, beige e nero
A lavish aesthetic featuring slanted streaks of green, grey, beige, and black.
Une esthétique riche avec des stries obliques dans les tons vert, gris, beige et noir.
Reiche Ästhetik mit schrägen Streifen in Grün-, Grau-, Beige- und Schwarztönen.

12 mm
163x324 cm

Available Finishes:
Polished



12 mm / 163x324 cm / Polished
Infinito 2.0 River Jade



12 mm / 163x324 cm / Polished
Infinito 2.0 River Jade

FLOOR Res Art Ash 120x120

Infinito 2.0 Amazzonite

Estetica intensa con toni di verde, azzurro e smeraldo, arricchita da vene e inserti oro e bronzo.
A intense aesthetic featuring green, pale blue, and emerald tones, enhanced with gold and bronze veining and inserts.
Une esthétique intense avec des tons vert, bleu et émeraude, enrichie de veines et d'incrustations or et bronze.
Intensive Ästhetik mit Grün-, Blau- und Smaragdtönen, angereichert mit Gold- und Bronzeadern und -einsätzen.

**12 mm
163x324 cm**

**Available Finishes:
Polished**

**12 mm / 163x324 cm / Polished
Infinito 2.0 Amazzonite**



12 mm / 163x324 cm / Honed
Infinito 2.0 Blue Roma
WALL Brit Ocean 6x24,6



Infinito 2.0 Blue Roma

Design elegante con celesti raffaelliani, venature beige e bianche simili a pennellate di Constable.

An elegant design featuring the sky blues favoured by Raphael and beige and white veining reminiscent of the brush strokes of Constable.

Un design élégant avec des bleu ciel raphaéliens, des veines beige et blanches semblables aux coups de pinceau de Constable.

Elegantes Design mit raffaelblauen, beigen und weißen Aderungen, die an die Pinselstriche von Constable erinnern.

12 mm
163x324 cm

Available Finishes:
Polished
Honed



12 mm / 163x324 cm / Honed
Infinito 2.0 Blue Roma

FLOOR Komi Natural 24x240
WALL Brit Almond 6x24,6



12 mm / 163x324 cm / Polished
Infinito 2.0 Emerald Green
FLOOR Pigmento Fango 120x120

Infinito 2.0 Emerald Green

Sfondo verde brillante sfumato crea un insieme armonioso e naturale.
This bright green background tile features shading that creates a harmonious, natural mood.
Le fond vert brillant nuancé crée un ensemble harmonieux et naturel.
Der hellgrüne Untergrund mit Farbverlauf schafft ein harmonisches und natürliches Ganzes.

12 mm
163x324 cm

Available Finishes:
Polished





Infinito 2.0 Agate Crystal Jade

Con i suoi verdi profondi e accenti dorati e bronzati,
Agate Crystal Jade emana design affascinante.
With its deep greens and gold and bronze accents,
Agate Crystal Jade exudes high-end allure.
Avec ses verts profonds et ses accents or et bronze,
Agate Crystal Jade dégage un design fascinant.
Mit seinen tiefen Grüntönen und goldenen und bronzefarbenen
Akzenten, weist Achat Crystal Jade ein reizvolles Design auf.

12 mm
163x324 cm

Available Finishes:
Polished

12 mm / 163x324 cm / Polished
Infinito 2.0 Agate Crystal Jade
FLOOR Homescape Sugar 120x120



12 mm / 163x324 cm / Polished
Infinito 2.0 Agate Crystal Jade
FLOOR Homescape Sugar 120x120



Infinito 2.0 Agate Crystal Lace

Pietra iconica dal fondo mosso che esprime la ricchezza del materiale con stratificazioni e inclusioni calde.

An iconic stone material featuring a gently undulating background that brings out its richness, enhanced by warm-toned layers and inserts.

Pierre iconique au fond mouvant qui exprime la richesse du matériau avec des stratifications et des inclusions chaudes.

Ikonscher Stein mit einem wellenförmigen Untergrund, der den Reichtum des Materials durch Schichten und warme Einschlüsse zum Ausdruck bringt.

**12 mm
163x324 cm**

**Available Finishes:
Polished**



12 mm / 163x324 cm / Polished
Infinito 2.0 Agate Crystal Lace

FLOOR Komi Original 24x120



Infinito 2.0 Agate Blue Velvet

I toni azzurri, celesti e grigi, con superficie lucida, creano un'estetica luminosa e coraggiosa.
Cerulean blue, sky blue, and grey tones with a high-gloss surface create a bold, bright aesthetic.
Les tons bleu ciel et gris, avec une surface brillante, créent une esthétique lumineuse et courageuse.
Die blauen, hellblauen und grauen Töne mit glänzender Oberfläche schaffen eine helle und mutige Ästhetik.

**12 mm
163x324 cm**

**Available Finishes:
Polished**

12 mm / 163x324 cm / Polished
Infinito 2.0 Agate Blue Velvet

FLOOR Pigmento Oro 120x120



12 mm / 163x324 cm / Polished
Infinito 2.0 Agate Blue Velvet
FLOOR Pigmento Oro 120x120

Infinito 2.0 Port Laurent

Sfondo nero e marrone, dettagli dorati e filamenti bianchi, esprimono il fascino della natura.
This black and brown background tile, featuring golden details and white streaks, embodies the beauty of nature.
Un fond noir et marron, des détails dorés et des filaments blancs, expriment le charme de la nature.
Schwarzer und brauner Untergrund, goldene Details und weiße Fäden bringen den Charme der Natur zum Ausdruck

**12 mm
163x324 cm**

**Available Finishes:
Polished**



12 mm / 163x324 cm / Polished
Infinito 2.0 Port Laurent



12 mm / 163x324 cm / Polished
Infinito 2.0 Pietra Grey

Infinito 2.0 Pietra Grey

Stratificazioni grigio-antracite e grigio-tortora con dettagli bianchi, per un aspetto pacato e versatile.
Anthracite grey and dove grey layers with white details, for a versatile materials that exudes calmness.
Des stratifications gris anthracite et gris tourterelle avec des détails blancs, pour un aspect paisible et polyvalent.
Anthrazit-graue und taubengraue Schichtenbildungen mit weißen Details für einen weichen, vielseitigen Look.

**12 mm
163x324 cm**

**Available Finishes:
Polished
Natural**



12 mm / 163x324 cm / Natural
Infinito 2.0 Pietra Grey

Infinito 2.0 Sahara Noir

Una superficie "total black" è attraversata da linee bianche con sfumature arancio e marrone.
A "total black" surface featuring white striations tinged with hints of orange and brown.
Une surface « total black » est traversée par des lignes blanches avec des nuances orange et marron.
Eine Fläche "total black" wird von weißen Linien mit Orange- und Brauntönen durchzogen.

12 mm
163x324 cm

Available Finishes:
Polished
Honed



12 mm / 163x324 cm / Polished
Infinito 2.0 Sahara Noir

INSPIRATIONS: DIFFERENT SURFACES

ISPIRAZIONI: ALTRE SUPERFICI

Una pregiata selezione di varie ispirazioni materiche: la pietra, con la sua intrinseca naturalezza che si declina in cromie che spaziano dalle calde nuances terrose ai toni più freddi e raffinati; il legno, emblema di armonia eterna ed eleganza innata, capace di evocare avvolgenti sensazioni di calore, comfort e accoglienza; e il cemento, espressione di una sobria raffinatezza, incarnazione di una contemporaneità ricercata. Ciascuna di queste ispirazioni rievoca e reinterpreta le texture della natura, emulandone le preziose peculiarità.

A selection of offerings inspired by a variety of materials. Effects include: stone, with its intrinsic naturalness, in colour options ranging from warm earthy tones to cooler chic shades; wood, the essence of eternal harmony and innate elegance that infuses rooms with a cosy warmth; and concrete, the stylishly understated embodiment of sophisticated contemporary tastes. Each of these different effects conjures up the textures of nature, recreating their unique distinguishing features.

Une sélection raffinée de diverses inspirations matiéristes : la pierre, avec son naturel intrinsèque qui se décline dans des couleurs allant de nuances terreuses chaudes à des tons plus froids et raffinés ; le bois, emblème d'harmonie éternelle et d'élégance innée, capable d'évoquer des sensations enveloppantes de chaleur, de confort et de convivialité ; et le béton, expression d'un raffinement sobre, incarnation d'une contemporanéité raffinée. Chacune de ces inspirations évoque et réinterprète les textures de la nature, en imitant les précieuses particularités.

Eine edle Auswahl verschiedener Materialinspirationen: Stein mit seiner ihm innewohnenden Natürlichkeit, die in Farben von warmen erdigen Nuancen bis hin zu kälteren und raffinierteren Tönen zum Ausdruck kommt; Holz, ein Emblem ewiger Harmonie und angeborener Eleganz, das in der Lage ist, umhüllende Empfindungen von Wärme, Komfort und Gastfreundschaft hervorzurufen; und Beton, Ausdruck nüchternen Raffinesse, Verkörperung einer raffinierten Modernität. Jede dieser Inspirationen evoziert und interpretiert die Texturen der Natur neu und ahmt ihre kostbaren Eigenheiten nach.

p.141
Stone Lab Sikelia

p.144
Stone Lab Nebula Grey

p.147
Stone Lab Nero Zimbabwe

p.150
Stone Lab Negresco

p.154
Stone Lab Colorado

p.157
Stone Lab Travertino Ebur

p.160
Stone Lab Travertino Fuscus

p.163
Stone Lab Jura White

p.164
Stone Lab Chianca

p.167
Stone Lab Slate Black

p.168
Stone Lab Silver Stone

p.171
Stone Lab Ceppo & Komi Elegant

p.172
Alpine Light Grey Vein

p.175
Portland Hood

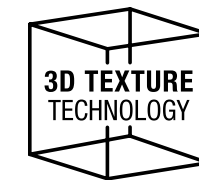

Stone Lab Sikelia

Ispirata alle pietre del sud Italia, dai delicati toni caldi.
Inspired by the stone materials of southern Italy, featuring subtle warm tones.
Inspirée des pierres du sud de l'Italie, aux tons chauds et délicats.
Inspiriert von den Steinen Südtaliens, mit zarten warmen Farbtönen.

12 mm
163x324 cm

Available Finishes:
Full 3D Texture

12 mm / 163x324 cm / Full 3D Texture
Stone Lab Sikelia



12 mm / 163x324 cm / Full 3D Texture
Stone Lab Sikelia
FLOOR Komi Classic 40x240

Stone Lab Nebula Grey

Venature intense e profonde dall'aspetto lavico e petroso.
Intense, deep veining for a distinctly rocky look reminiscent of lava.
Des veines intenses et profondes à l'aspect lavique et pétrifié.
Intensive und tiefe Aderungen mit lavafarbenem und steinigem Aussehen.

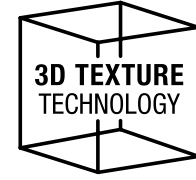

12 mm
163x324 cm

Available Finishes:
Full 3D Texture



12 mm / 163x324 cm / Full 3D Texture
Stone Lab Nebula Grey



12 mm / 163x324 cm / Full 3D Texture
Stone Lab Nebula Grey

FLOOR Homescape Coal 120x120

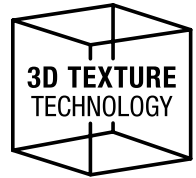

Stone Lab Nero Zimbabwe

Profondità grafica dall'intenso colore scuro.
Visual depth with rich, dark shades.
Une profondeur graphique de couleur foncée intense.
Grafische Tiefe mit intensiver dunkler Farbe.

12 mm
163x324 cm

Available Finishes:
Full 3D Texture

12 mm / 163x324 cm / Full 3D Texture
Stone Lab Nero Zimbabwe



12 mm / 163x324 cm / Full 3D Texture

Stone Lab Zimbabwe

FLOOR Alpine Silk Cross 120x120

WALL Dream Palace 120x278 / Alpine Silk Vein 120x278

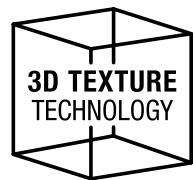

Stone Lab Negresco

Pietra naturale dalla struttura granulosa e dal fondo grigio.
Natural stone with a grainy texture and grey background.
Pierre naturelle à la structure granuleuse et au fond gris.
Naturstein mit körniger Struktur und grauem Untergrund.

**12 mm
163x324 cm**

**Available Finishes:
3D Texture Real Matt**



12 mm / 163x324 cm / 3D Texture Real Matt
Stone Lab Negresco



12 mm / 163x324 cm / 3D Texture / Real Matt
Stone Lab Negresco
FLOOR Komi Classic 24x240

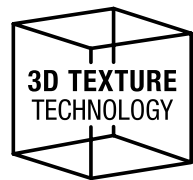

Stone Lab Colorado

12 mm
163x324 cm

Piccole striature bianche su fondo beige dal morbido e piacevole effetto materico.
Small white streaks against a beige background create a gentle, pleasingly textured effect.
De petites stries blanches sur fond beige à l'effet matiériste doux et agréable.
Kleine weiße Streifen auf beigem Untergrund mit einem weichen und angenehmen Textureffekt.

Available Finishes:
3D Texture



12 mm / 163x324 cm / 3D Texture
Stone Lab Colorado
FLOOR Woodblock Scratch Oak 24x240

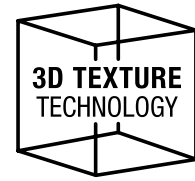

Stone Lab Travertino Ebur

Il fascino eterno della pietra simbolo di eleganza.
The eternal beauty of stone, symbol of elegance.
Le charme éternel de la pierre symbole d'élégance.
Der ewige Charme des Steins, ein Symbol der Eleganz.

12 mm
163x324 cm

Available Finishes:
Full 3D Texture Honed
Real Matt

12 mm / 163x324 cm / Full 3D Texture Honed
Stone Lab Travertino Ebur



12 mm / 163x324 cm / Real Matt
Stone Lab Travertino Ebur
FLOOR Komi Natural 24x240

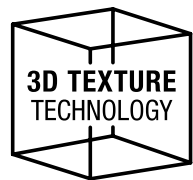

Stone Lab Travertino Fuscus

Protagonisti i toni bruni della terra.
Show-stealing shades of earthy brown.
Les tons bruns de la terre en sont les protagonistes.
Protagonisten sind die brauen Farbtöne der Erde.

**12 mm
163x324 cm**

**Available Finishes:
Full 3D Texture Honed
Real Matt**



12 mm / 163x324 cm / Real Matt
Stone Lab Travertino Fuscus
FLOOR Royal Travertino Navona Cross 120x120



Stone Lab Jura White

Tutti i dettagli delle pietre calcaree svizzere alpine.
All the detail of Swiss Alpine limestone.
Tous les détails des pierres calcaires suisses alpines.
Alle Details der Kalksteine aus den Schweizer Alpen.

12 mm
163x324 cm

Available Finishes:
Real Matt

12 mm / 163x324 cm / Real Matt
Stone Lab Jura White
FLOOR Homescape Clay 120x120

Stone Lab Chianca

Tonalità calde e neutre dalle atmosfere mediterranee.
Warm, neutral shades with a Mediterranean ambiance.
Des tons chauds et neutres aux atmosphères méditerranéennes.
Warme und neutrale Töne mit mediterraner Atmosphäre.

12 mm
163x324 cm

Available Finishes:
Real Matt



12 mm / 163x324 cm / Real Matt
Stone Lab Chianca
FLOOR Portland Lassen 120x120



Stone Lab Slate Black

Sofisticata tonalità di nero e antracite, dall'estetica misteriosa.
Sophisticated shades of black and anthracite, with a mysterious aesthetic.
Des nuances sophistiquées de noir et d'antracite, à l'esthétique mystérieuse.
Raffinierte Schwarz- und Anthrazittöne mit einer geheimnisvollen Ästhetik.

**12 mm
163x324 cm**

**Available Finishes:
Real Matt**

12 mm / 163x324 cm / Real Matt
Stone Lab Slate Black

FLOOR Background Snowy 120x120

Stone Lab Silver Stone

Una superficie grigia raffinata, impreziosita da una texture.
A stylish grey option, enhanced with a textured surface.
Une surface grise raffinée, enrichie d'une texture.
Eine raffinierte graue Oberfläche, bereichert durch eine Textur.

**12 mm
163x324 cm**

**Available Finishes:
Natural**



**12 mm / 163x324 cm / Natural
Stone Lab Silver Stone**

FLOOR Background Caviar 120x120
WALL Background Caviar 120x278

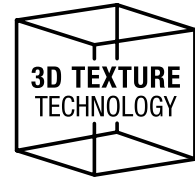

Stone Lab Ceppo & Komi Elegant

Un perfetto abbinamento tra effetto rovere e l'iconica pietra italiana del Ceppo di Grè.
A perfect combination of oak effect and iconic Italian stone Ceppo di Grè.
Une combinaison parfaite entre l'effet chêne et la pierre italienne emblématique du Ceppo di Grè.
Eine perfekte Kombination zwischen dem Eichen-Effekt und dem ikonischen italienischen Stein des Ceppo di Grè.

**12 mm
163x324 cm**

**Stone Lab Ceppo Available Finishes:
Full 3D Texture
Real Matt**

**Komi Elegant Available Finishes:
Natural**

12 mm / 163x324 cm / Full 3D Texture
Stone Lab Ceppo

12 mm / 163x324 cm / Natural
Komi Elegant
FLOOR Komi Elegant 40x240

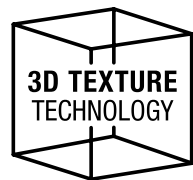

Alpine Light Grey Vein

Nuove sintonie tra superfici e stili di vita a ritmo lento.
New harmonies between surfaces and life lived at a slow pace.
De nouvelles syntonies entre surfaces et
styles de vie au rythme plus lent.
Neue Harmonien zwischen ruhigen Flächenbildern
und langsamen Lebensrhythmen.

**12 mm
163x324 cm**

**Available Finishes:
3D Texture**



12 mm / 163x324 cm / 3D Texture
Alpine Light Grey Vein
FLOOR Alpine Light Grey Cross 120x120



12 mm / 163x324 cm / Natural
Portland Hood

Portland Hood

Design lineare che unisce estetica e funzionalità per arredi versatili.
A linear design that combines aesthetics and functionality for versatile creations.
Design linéaire alliant esthétique et fonctionnalité pour des décors polyvalents.
Geradliniges Design, das Ästhetik und Funktionalität für eine vielseitige Einrichtung vereint.

**12 mm
163x324 cm**

**Available Finishes:
Natural**



12 mm / 163x324 cm / Natural
Portland Hood

COLLECTIONS

COLLEZIONI

p.180
Infinito 2.0

p.302
Planeto

p.318
Monochrome

p.276
Stone Lab

p.308
Portland

p.300
Alpine

p.314
Komi

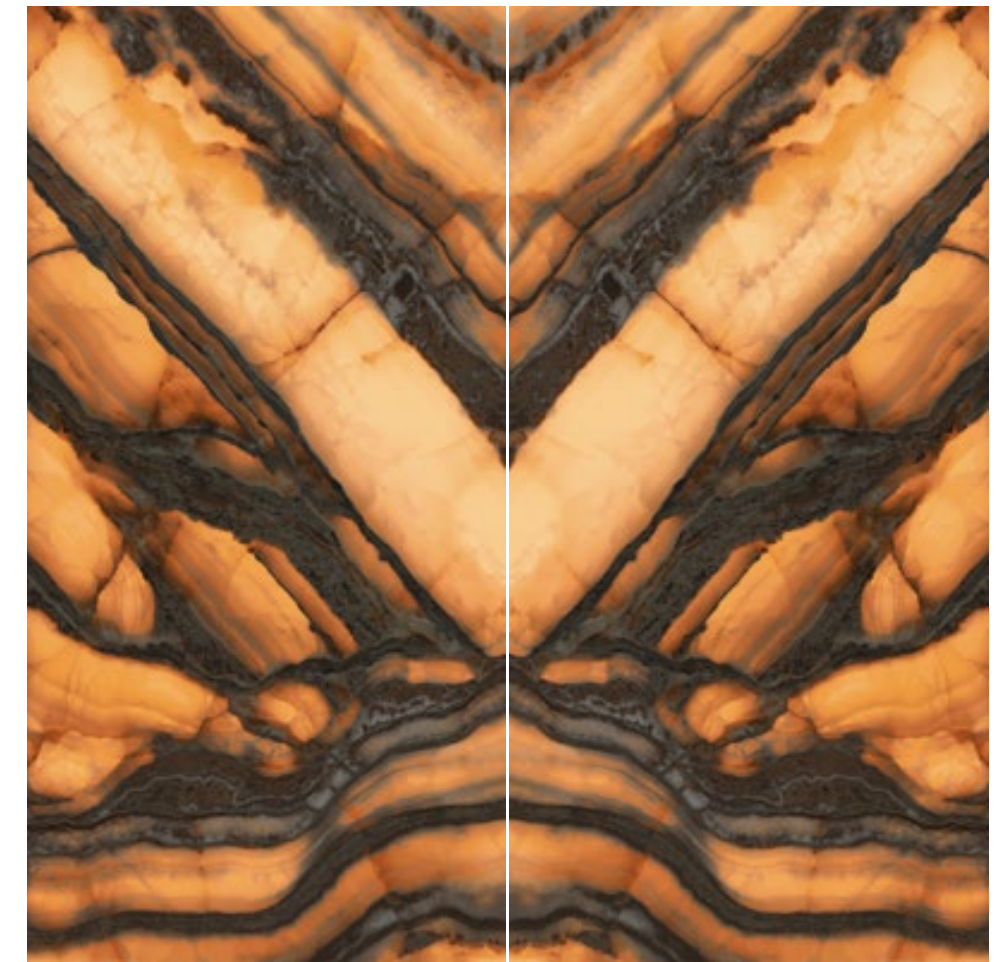
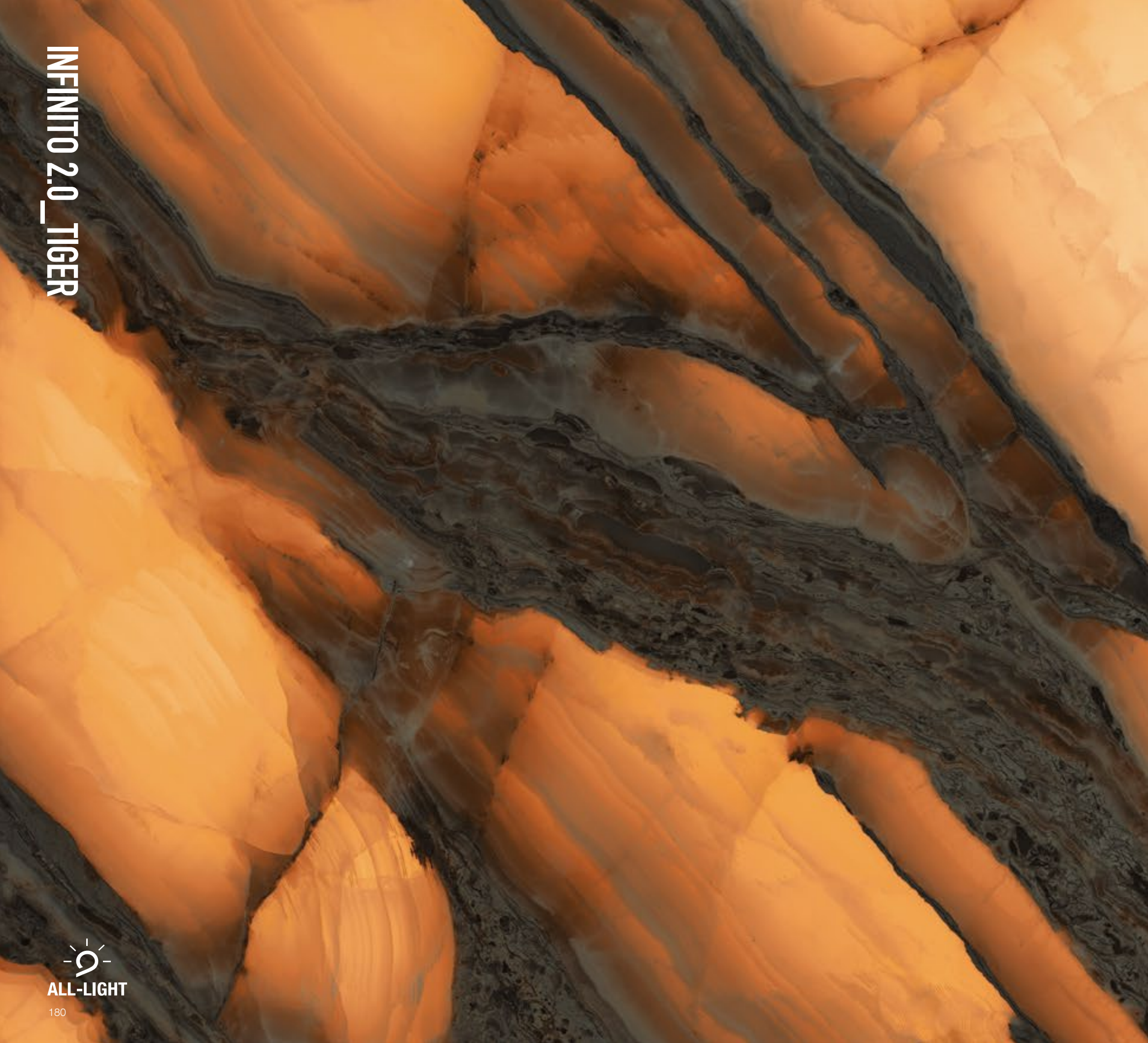

INF3161 Tiger ALL-LIGHT polished_A

INF3162 Tiger ALL-LIGHT polished_B

1 SURFACE

ALL-LIGHT Polished

163x324

64,17"x127,56"

12 mm

Impasto: Bianco
Body: White

L'effetto Bookmatch tra le diverse lastre è soggetto alla tolleranza tipica del prodotto lapideo.
The bookmatching effect created by placing different slabs together is subject to the usual joint specifications of stone tiles. | L'effet Bookmatch entre différentes dalles est soumis à la tolérance typique du produit en pierre. | Der Effekt des Bookmatching zwischen den verschiedenen Platten unterliegt der typischen Toleranz des Produktes aus Stein.

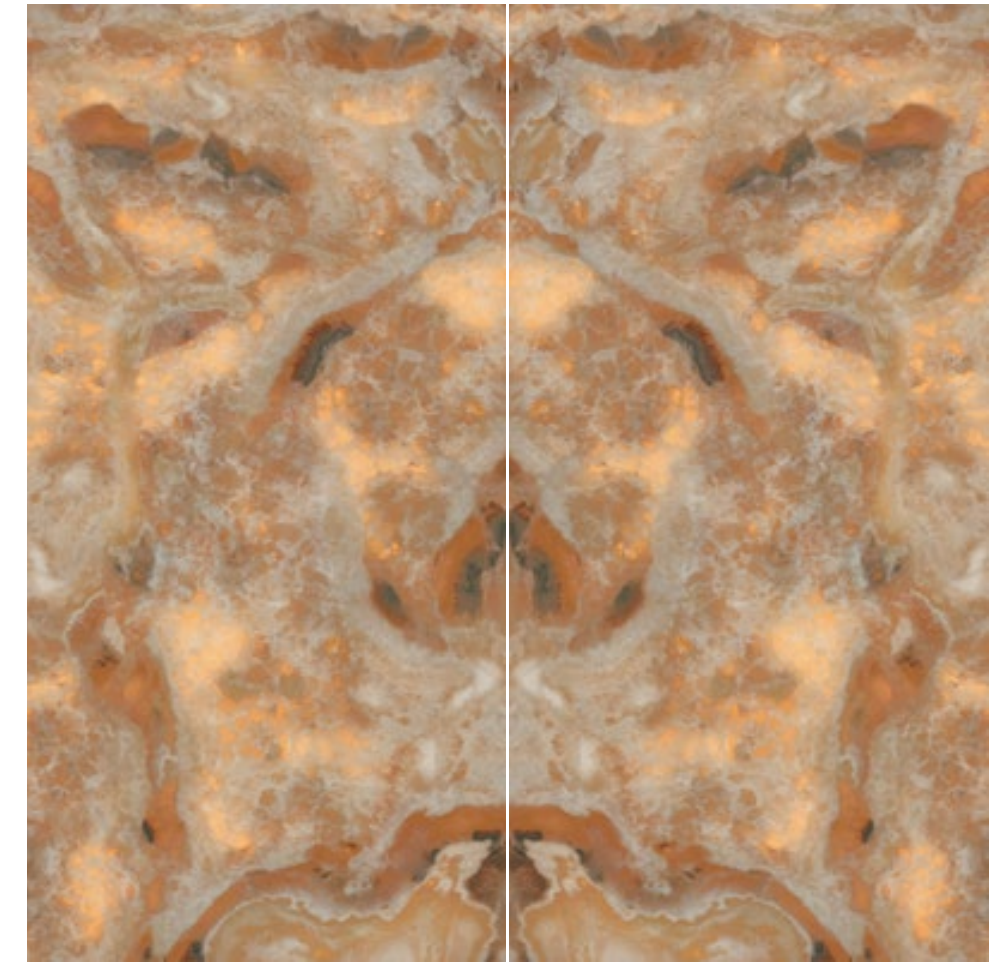
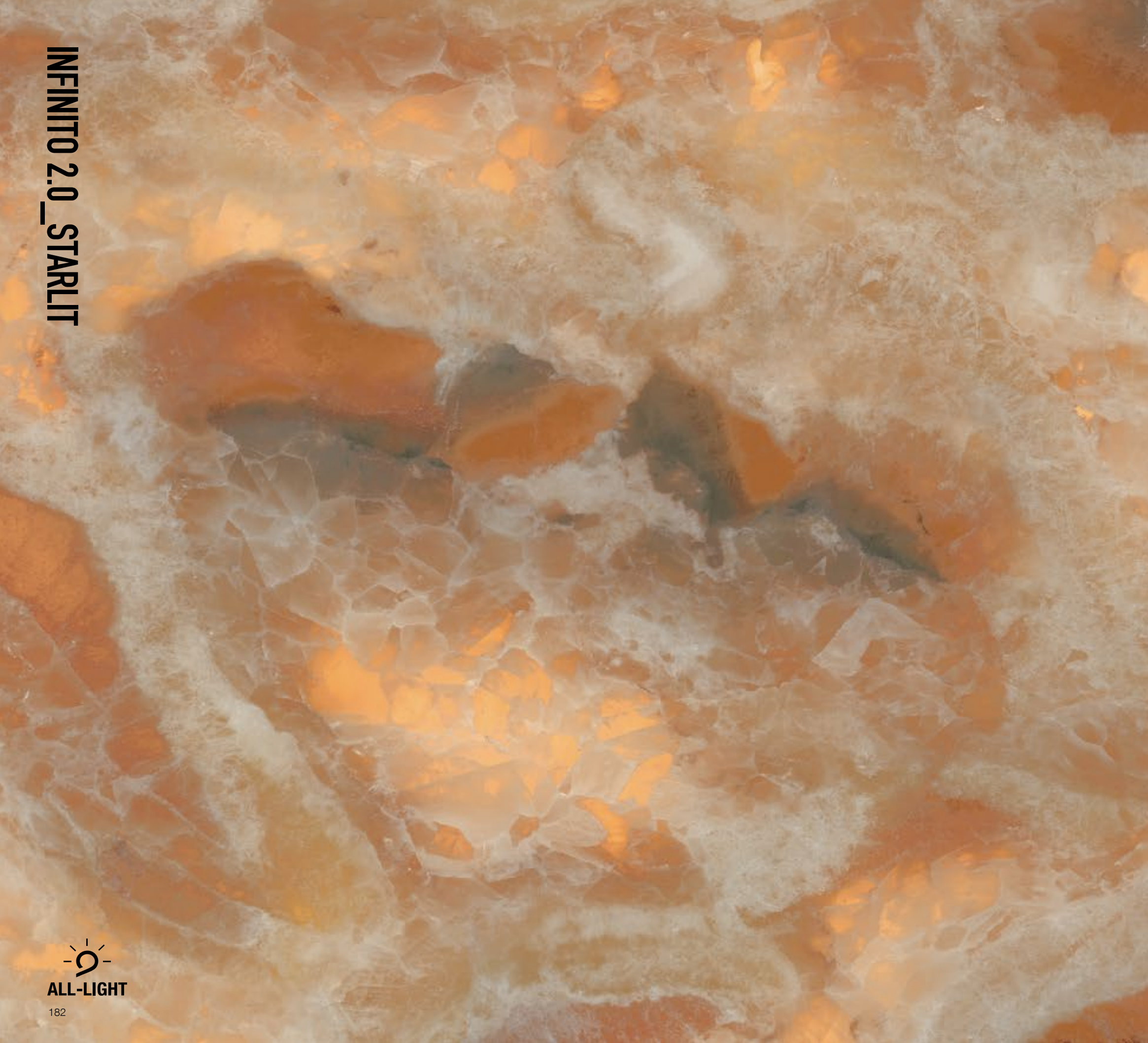

INF3170 Starlit ALL-LIGHT polished_A

INF3171 Starlit ALL-LIGHT polished_B

1 SURFACE

ALL-LIGHT Polished

L'effetto Bookmatch tra le diverse lastre è soggetto alla tolleranza tipica del prodotto lapideo.
The bookmatching effect created by placing different slabs together is subject to the usual joint specifications of stone tiles. | L'effet Bookmatch entre différentes dalles est soumis à la tolérance typique du produit en pierre. | Der Effekt des Bookmatching zwischen den verschiedenen Platten unterliegt der typischen Toleranz des Produktes aus Stein.

163x324

64,17"x127,56"

12 mm

Impasto: Bianco
Body: White

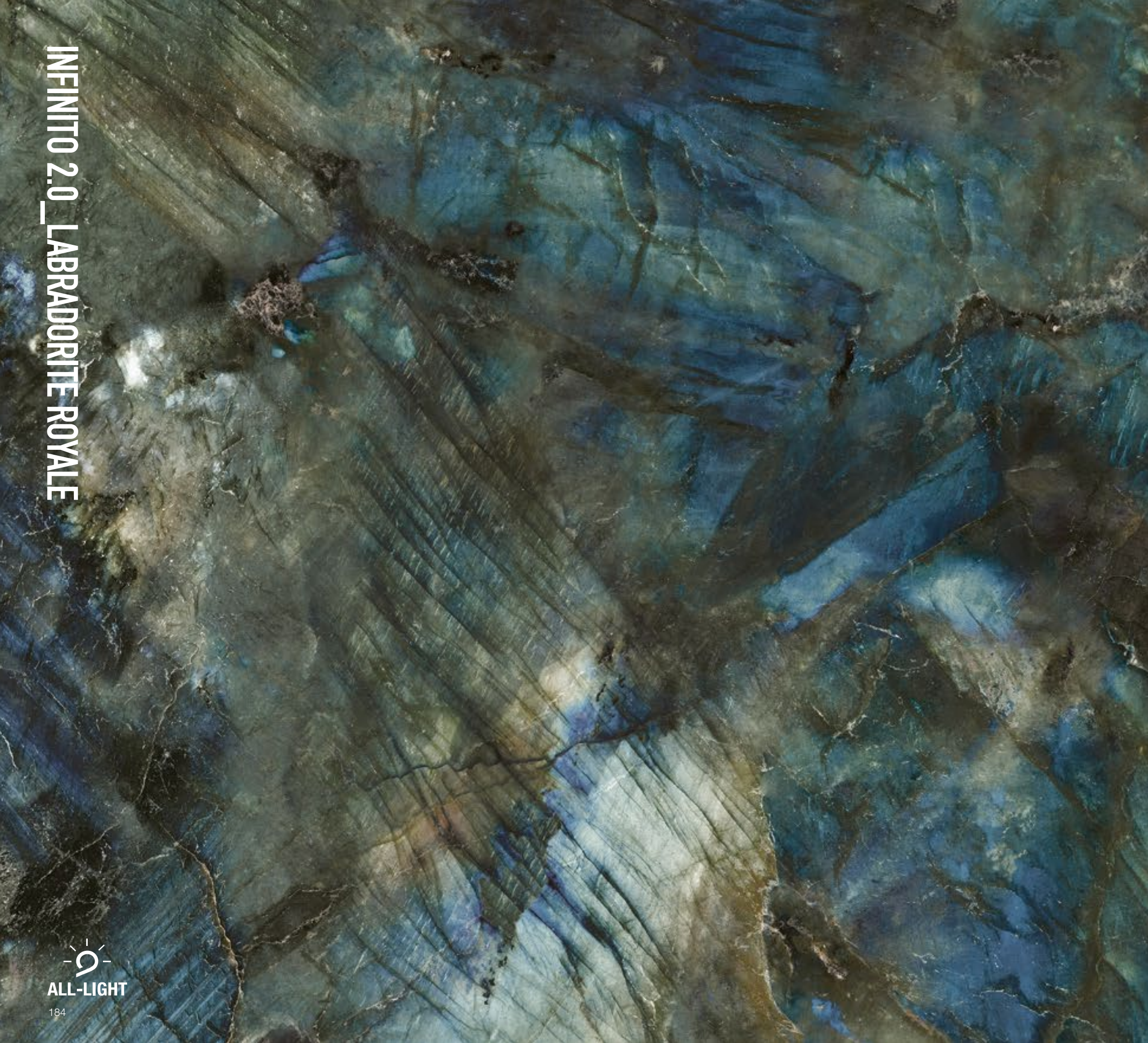

INF3179 Labradorite Royale ALL-LIGHT polished_A INF3180 Labradorite Royale ALL-LIGHT polished_B

1 SURFACE

ALL-LIGHT Polished

L'effetto Bookmatch tra le diverse lastre è soggetto alla tolleranza tipica del prodotto lapideo.
The bookmatching effect created by placing different slabs together is subject to the usual joint specifications of stone tiles. | L'effet Bookmatch entre différentes dalles est soumis à la tolérance typique du produit en pierre. | Der Effekt des Bookmatching zwischen den verschiedenen Platten unterliegt der typischen Toleranz des Produktes aus Stein.

163x324

64,17"x127,56"

12 mm

Impasto: Bianco
Body: White



INF3152 Calacatta Paris *Full 3D texture_A*
INF3143 Calacatta Paris *polished_A*

INF3153 Calacatta Paris *Full 3D texture_B*
INF3144 Calacatta Paris *polished_B*

2 SURFACES

Full 3D Texture | Polished

L'effetto Bookmatch tra le diverse lastre è soggetto alla tolleranza tipica del prodotto lapideo.
The bookmatching effect created by placing different slabs together is subject to the usual joint specifications of stone tiles. | L'effet Bookmatch entre différentes dalles est soumis à la tolérance typique du produit en pierre. | Der Effekt des Bookmatching zwischen den verschiedenen Platten unterliegt der typischen Toleranz des Produktes aus Stein.

163x324

64,17"x127,56"

12 mm

Impasto: Bianco
Body: White



INF3261 Tiffany Green *polished_A*

INF3262 Tiffany Green *polished_B*

1 SURFACE

Polished

L'effetto Bookmatch tra le diverse lastre è soggetto alla tolleranza tipica del prodotto lapideo.
The bookmatching effect created by placing different slabs together is subject to the usual joint specifications of stone tiles. | L'effet Bookmatch entre différentes dalles est soumis à la tolérance typique du produit en pierre. | Der Effekt des Bookmatching zwischen den verschiedenen Platten unterliegt der typischen Toleranz des Produktes aus Stein.

163x324

64,17"x127,56"

12 mm

Impasto: Bianco
Body: White

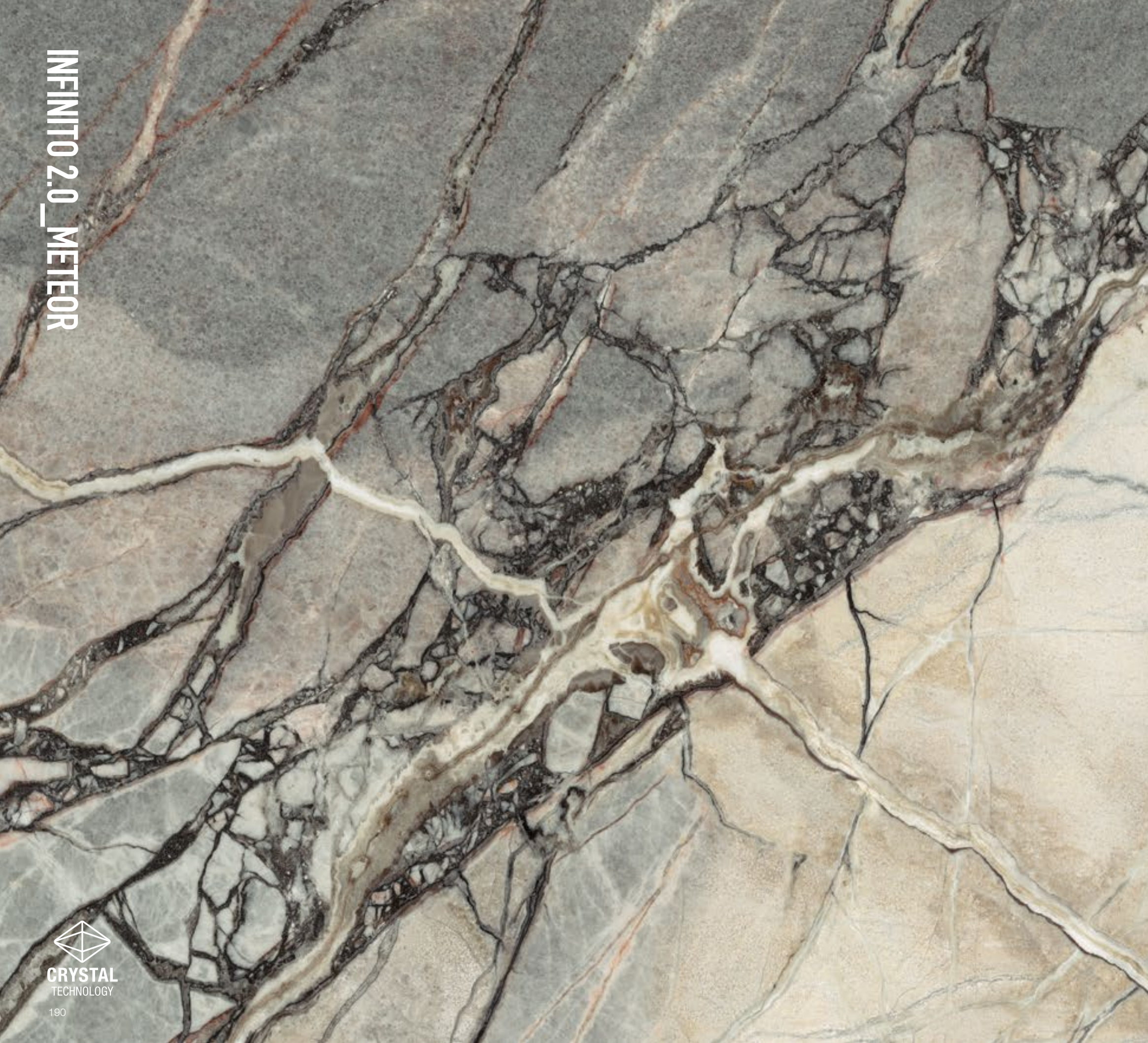

INF2883 Meteor *crystal polished_A*

INF2884 Meteor *crystal polished_B*

1 SURFACE

Crystal Polished

L'effetto Bookmatch tra le diverse lastre è soggetto alla tolleranza tipica del prodotto lapideo.
The bookmatching effect created by placing different slabs together is subject to the usual joint specifications of stone tiles. | L'effet Bookmatch entre différentes dalles est soumis à la tolérance typique du produit en pierre. | Der Effekt des Bookmatching zwischen den verschiedenen Platten unterliegt der typischen Toleranz des Produktes aus Stein.

163x324

64,17"x127,56"

12 mm

Impasto: Bianco
Body: White



INF2889 Thassos *crystal polished*

1 SURFACE
Crystal Polished

163x324
64,17"x127,56"

12 mm

Impasto: Bianco
Body: White



INF2872 Statuarietto *natural*

1 SURFACE
Natural

163x324
64,17"x127,56"

12 mm

Impasto: Bianco
Body: White

INFINITO 2.0_BLACK PEARL



INF2867 Black Pearl *natural*

1 SURFACE
Natural

163x324
64,17"x127,56"

12 mm

Impasto: Nero
Body: Black

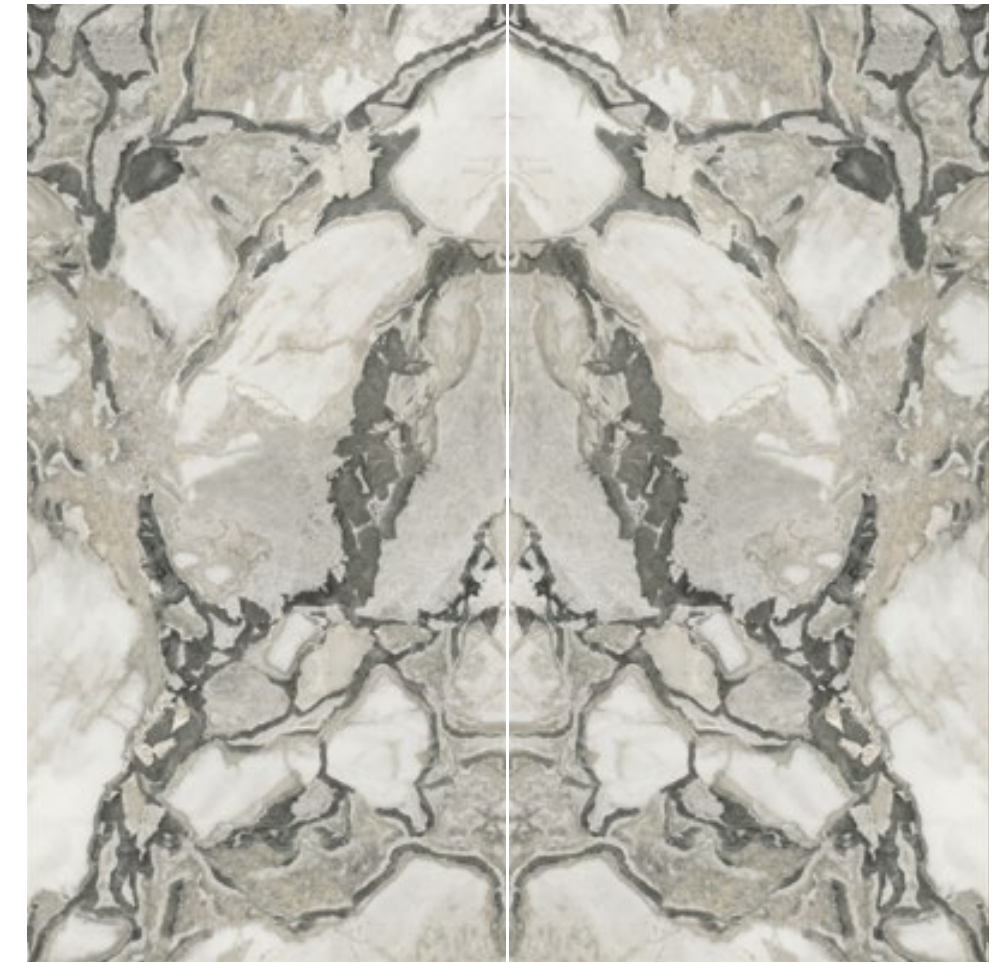

INF2524 Cliff White Full 3D texture_A

INF2525 Cliff White Full 3D texture_B

1 SURFACE

Full 3D Texture

163x324

64,17"x127,56"

12 mm

Impasto: Bianco
Body: White

L'effetto Bookmatch tra le diverse lastre è soggetto alla tolleranza tipica del prodotto lapideo.
The bookmatching effect created by placing different slabs together is subject to the usual joint specifications of stone tiles. | L'effet Bookmatch entre différentes dalles est soumis à la tolérance typique du produit en pierre. | Der Effekt des Bookmatching zwischen den verschiedenen Platten unterliegt der typischen Toleranz des Produktes aus Stein.



INF2526 Cream Diamonds *Full 3D texture_A* INF2527 Cream Diamonds *Full 3D texture_B*
INF3086 Cream Diamonds *Full 3D texture polished_A* INF3087 Cream Diamonds *Full 3D texture polished_B*

2 SURFACES

Full 3D Texture | Full 3D Texture Polished

L'effetto Bookmatch tra le diverse lastre è soggetto alla tolleranza tipica del prodotto lapideo.
The bookmatching effect created by placing different slabs together is subject to the usual joint specifications of stone tiles. | L'effet Bookmatch entre différentes dalles est soumis à la tolérance typique du produit en pierre. | Der Effekt des Bookmatching zwischen den verschiedenen Platten unterliegt der typischen Toleranz des Produktes aus Stein.

163x324

64,17"x127,56"

12 mm

Impasto: Bianco
Body: White





INF2517 Breccia Van Gogh *polished_A*

INF2518 Breccia Van Gogh *polished_B*

1 SURFACE

Polished

L'effetto Bookmatch tra le diverse lastre è soggetto alla tolleranza tipica del prodotto lapideo.
The bookmatching effect created by placing different slabs together is subject to the usual joint specifications of stone tiles. | L'effet Bookmatch entre différentes dalles est soumis à la tolérance typique du produit en pierre. | Der Effekt des Bookmatching zwischen den verschiedenen Platten unterliegt der typischen Toleranz des Produktes aus Stein.

163x324

64,17"x127,56"

12 mm

Impasto: Grigio
Body: Grey



INF2497 Luxury Gold *polished_A*

INF2498 Luxury Gold *polished_B*

1 SURFACE

Polished

L'effetto Bookmatch tra le diverse lastre è soggetto alla tolleranza tipica del prodotto lapideo.
The bookmatching effect created by placing different slabs together is subject to the usual joint specifications of stone tiles. | L'effet Bookmatch entre différentes dalles est soumis à la tolérance typique du produit en pierre. | Der Effekt des Bookmatching zwischen den verschiedenen Platten unterliegt der typischen Toleranz des Produktes aus Stein.

163x324

64,17"x127,56"

12 mm

Impasto: Bianco
Body: White



INF1441 Patagonia *polished_A*
INF2307 Patagonia *natural_A*

INF1442 Patagonia *polished_B*
INF2308 Patagonia *natural_B*

2 SURFACES

Polished | Natural

L'effetto Bookmatch tra le diverse lastre è soggetto alla tolleranza tipica del prodotto lapideo.
The bookmatching effect created by placing different slabs together is subject to the usual joint specifications of stone tiles. | L'effet Bookmatch entre différentes dalles est soumis à la tolérance typique du produit en pierre. | Der Effekt des Bookmatching zwischen den verschiedenen Platten unterliegt der typischen Toleranz des Produktes aus Stein.

163x324

64,17"x127,56"

12 mm

Impasto: Bianco
Body: White



INF2169 Royal Creamy *natural_A*

INF2170 Royal Creamy *natural_B*

1 SURFACE

Natural

L'effetto Bookmatch tra le diverse lastre è soggetto alla tolleranza tipica del prodotto lapideo.
The bookmatching effect created by placing different slabs together is subject to the usual joint specifications of stone tiles. | L'effet Bookmatch entre différentes dalles est soumis à la tolérance typique du produit en pierre. | Der Effekt des Bookmatching zwischen den verschiedenen Platten unterliegt der typischen Toleranz des Produktes aus Stein.

163x324

64,17"x127,56"

12 mm

Impasto: Grigio
Body: Grey



INF539 Fior Di Bosco *honed*
INF540 Fior Di Bosco *polished*

2 SURFACES

Honed | Polished

163x324

64,17"x127,56"

12 mm

Impasto: Grigio
Body: Grey

La superficie HONED è una finitura di nuova concezione che risulta più opaca rispetto alla versione POLISHED. Le differenze di lucentezza ed eventuali disomogeneità di aspetto sono quindi da considerare caratteristiche intrinseche di questa superficie.

The HONED surface is a new finish that gives a more matt effect than the POLISHED version. Any differences in shine and appearance are therefore a natural feature of this surface finish.

INFINITO 2.0_ONICE WHITE



INF1226 Onice White *polished*

1 SURFACE
Polished

163x324
64,17"x127,56"

12 mm

Impasto: Bianco
Body: White





INF3084 Taj Mahal Light *polished_A*

INF3085 Mahal Light *polished_B*

1 SURFACE

Polished

L'effetto Bookmatch tra le diverse lastre è soggetto alla tolleranza tipica del prodotto lapideo.
The bookmatching effect created by placing different slabs together is subject to the usual joint specifications of stone tiles. | L'effet Bookmatch entre différentes dalles est soumis à la tolérance typique du produit en pierre. | Der Effekt des Bookmatching zwischen den verschiedenen Platten unterliegt der typischen Toleranz des Produktes aus Stein.

163x324

64,17"x127,56"

12 mm

Impasto: Bianco
Body: White



INF2046 Taj Mahal *polished_A*

INF2047 Taj Mahal *polished_B*

1 SURFACE

Polished

L'effetto Bookmatch tra le diverse lastre è soggetto alla tolleranza tipica del prodotto lapideo.
The bookmatching effect created by placing different slabs together is subject to the usual joint specifications of stone tiles. | L'effet Bookmatch entre différentes dalles est soumis à la tolérance typique du produit en pierre. | Der Effekt des Bookmatching zwischen den verschiedenen Platten unterliegt der typischen Toleranz des Produktes aus Stein.

163x324

64,17"x127,56"

12 mm

Impasto: Bianco
Body: White



INF2238 Gold River *polished_A*

INF2330 Gold River *polished_B*

1 SURFACE

Polished

L'effetto Bookmatch tra le diverse lastre è soggetto alla tolleranza tipica del prodotto lapideo.
The bookmatching effect created by placing different slabs together is subject to the usual joint specifications of stone tiles. | L'effet Bookmatch entre différentes dalles est soumis à la tolérance typique du produit en pierre. | Der Effekt des Bookmatching zwischen den verschiedenen Platten unterliegt der typischen Toleranz des Produktes aus Stein.

163x324

64,17"x127,56"

12 mm

Impasto: Bianco
Body: White

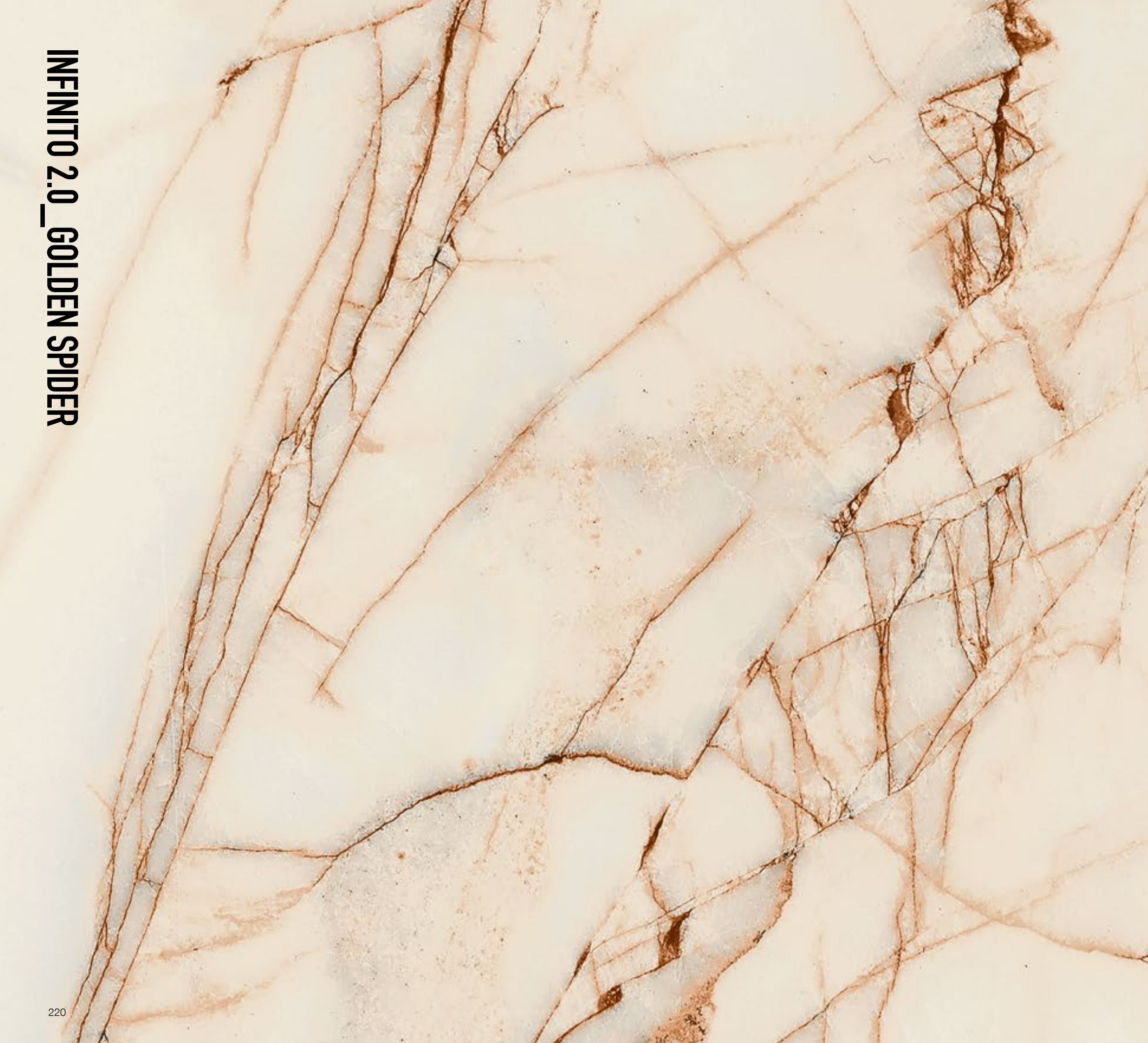

INF2309 Golden Spider *polished_A*

INF2310 Golden Spider *polished_B*

1 SURFACE

Polished

L'effetto Bookmatch tra le diverse lastre è soggetto alla tolleranza tipica del prodotto lapideo.
The bookmatching effect created by placing different slabs together is subject to the usual joint specifications of stone tiles. | L'effet Bookmatch entre différentes dalles est soumis à la tolérance typique du produit en pierre. | Der Effekt des Bookmatching zwischen den verschiedenen Platten unterliegt der typischen Toleranz des Produktes aus Stein.

163x324

64,17"x127,56"

12 mm

Impasto: Bianco
Body: White

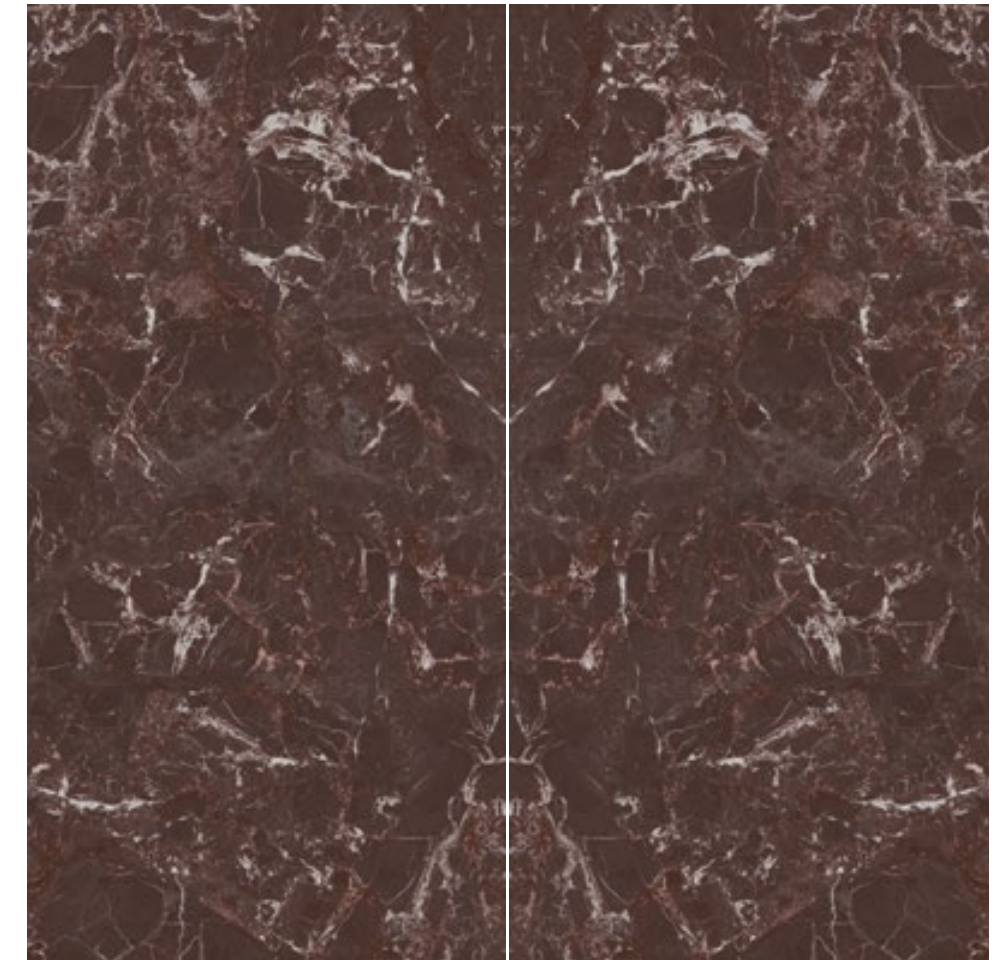

INF2515 Rosso Lepanto *polished_A*

INF2516 Rosso Lepanto *polished_B*

1 SURFACE

Polished

L'effetto Bookmatch tra le diverse lastre è soggetto alla tolleranza tipica del prodotto lapideo.
The bookmatching effect created by placing different slabs together is subject to the usual joint specifications of stone tiles. | L'effet Bookmatch entre différentes dalles est soumis à la tolérance typique du produit en pierre. | Der Effekt des Bookmatching zwischen den verschiedenen Platten unterliegt der typischen Toleranz des Produktes aus Stein.

163x324

64,17"x127,56"

12 mm

Impasto: Nero
Body: Black



INF2511 Calacatta Viola *polished_A*

INF2512 Calacatta Viola *polished_B*

1 SURFACE

Polished

L'effetto Bookmatch tra le diverse lastre è soggetto alla tolleranza tipica del prodotto lapideo.
The bookmatching effect created by placing different slabs together is subject to the usual joint specifications of stone tiles. | L'effet Bookmatch entre différentes dalles est soumis à la tolérance typique du produit en pierre. | Der Effekt des Bookmatching zwischen den verschiedenen Platten unterliegt der typischen Toleranz des Produktes aus Stein.

163x324

64,17"x127,56"

12 mm

Impasto: Bianco
Body: White



INF1198 Capraia *honed_A*
 INF1200 Capraia *polished_A*
 INF2295 Capraia *natural_A*

INF1199 Capraia *honed_B*
 INF1201 Capraia *polished_B*
 INF2296 Capraia *natural_B*

3 SURFACES

Honed | Polished | Natural

La superficie HONED è una finitura di nuova concezione che risulta più opaca rispetto alla versione POLISHED. Le differenze di lucentezza ed eventuali disomogeneità di aspetto sono quindi da considerare caratteristiche intrinseche di questa superficie.
 The HONED surface is a new finish that gives a more matt effect than the POLISHED version. Any differences in shine and appearance are therefore a natural feature of this surface finish.

L'effetto Bookmatch tra le diverse lastre è soggetto alla tolleranza tipica del prodotto lapideo.
 The bookmatching effect created by placing different slabs together is subject to the usual joint specifications of stone tiles. | L'effet Bookmatch entre différentes dalles est soumis à la tolérance typique du produit en pierre. | Der Effekt des Bookmatching zwischen den verschiedenen Platten unterliegt der typischen Toleranz des Produktes aus Stein.

163x324

64,17"x127,56"

12 mm

Impasto: Bianco
 Body: White



INF2304 Elegant White *natural_A*

INF2305 Elegant White *natural_B*

1 SURFACE

Natural

L'effetto Bookmatch tra le diverse lastre è soggetto alla tolleranza tipica del prodotto lapideo.
The bookmatching effect created by placing different slabs together is subject to the usual joint specifications of stone tiles. | L'effet Bookmatch entre différentes dalles est soumis à la tolérance typique du produit en pierre. | Der Effekt des Bookmatching zwischen den verschiedenen Platten unterliegt der typischen Toleranz des Produktes aus Stein.

163x324

64,17"x127,56"

12 mm

Impasto: Bianco

Body: White



INF1079 Carrara C *honed*
INF1080 Carrara C *polished*

2 SURFACES

Honed | Polished

163x324

64,17"x127,56"

12 mm

Impasto: Bianco
Body: White

La superficie HONED è una finitura di nuova concezione che risulta più opaca rispetto alla versione POLISHED. Le differenze di lucentezza ed eventuali disomogeneità di aspetto sono quindi da considerare caratteristiche intrinseche di questa superficie.

The HONED surface is a new finish that gives a more matt effect than the POLISHED version. Any differences in shine and appearance are therefore a natural feature of this surface finish.



INF937 Statuario Extra *honed_12mm_A*
 INF938 Statuario Extra *polished_12mm_A*
 INF1464 Statuario Extra *natural_12mm_A*

INF939 Statuario Extra *honed_12mm_B*
 INF940 Statuario Extra *polished_12mm_B*
 INF1465 Statuario Extra *natural_12mm_B*

INF1384 Statuario Extra *polished_20mm_A*
 INF1382 Statuario Extra *natural_20mm_A*

INF1385 Statuario Extra *polished_20mm_B*
 INF1383 Statuario Extra *natural_20mm_B*

3 SURFACES

Honed | Polished | Natural

La superficie HONED è una finitura di nuova concezione che risulta più opaca rispetto alla versione POLISHED. Le differenze di lucentezza ed eventuali disomogeneità di aspetto sono quindi da considerare caratteristiche intrinseche di questa superficie.
 The HONED surface is a new finish that gives a more matt effect than the POLISHED version. Any differences in shine and appearance are therefore a natural feature of this surface finish.

L'effetto Bookmatch tra le diverse lastre è soggetto alla tolleranza tipica del prodotto lapideo.
 The bookmatching effect created by placing different slabs together is subject to the usual joint specifications of stone tiles. | L'effet Bookmatch entre différentes dalles est soumis à la tolérance typique du produit en pierre. | Der Effekt des Bookmatching zwischen den verschiedenen Platten unterliegt der typischen Toleranz des Produktes aus Stein.

163x324

64,17"x127,56"

12/20 mm

Impasto: Bianco
 Body: White

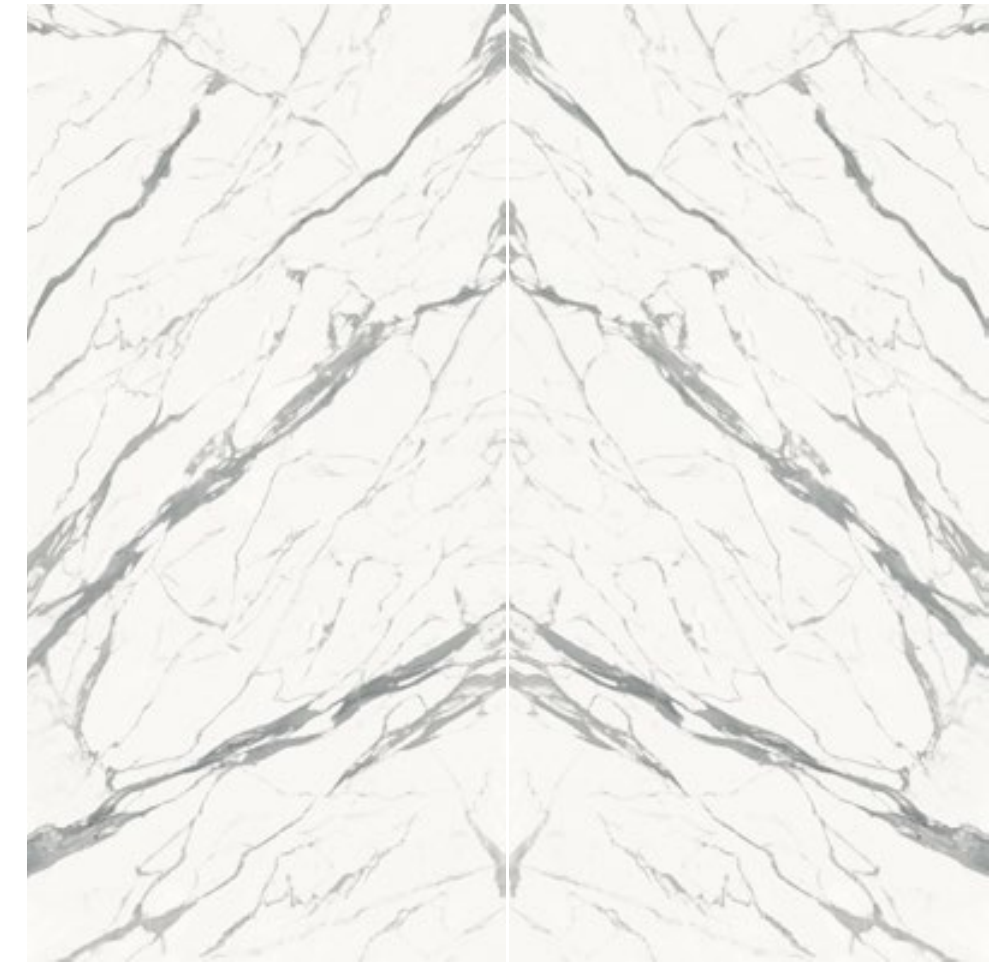

* **INF3267** Statuario Extra ALL-VEIN *polished*
20mm_A

* **INF3269** Statuario Extra ALL-VEIN *natural*
20mm_A

* **INF3268** Statuario Extra ALL-VEIN *polished*
20mm_B

* **INF3270** Statuario Extra ALL-VEIN *natural*
20mm_B

2 SURFACES

Polished | Natural

L'effetto Bookmatch tra le diverse lastre è soggetto alla tolleranza tipica del prodotto lapideo.
The bookmatching effect created by placing different slabs together is subject to the usual joint specifications of stone tiles. | L'effet Bookmatch entre différentes dalles est soumis à la tolérance typique du produit en pierre. | Der Effekt des Bookmatching zwischen den verschiedenen Platten unterliegt der typischen Toleranz des Produktes aus Stein.

* **Tecnologia con vena passante. Articoli non stuoiati.** | Technology for full-body veining. Items without mesh backing. | Technologie avec veinage traversant. Articles sans filet. | Technologie mit durchgehender Ader. Nicht mit Gewebe bewehrte Artikel.

163x324

64,17"x127,56"

20 mm

Impasto: Bianco
Body: White



INF2863 Lincoln *natural_A*

INF2305 Lincoln *natural_B*

1 SURFACE

Natural

L'effetto Bookmatch tra le diverse lastre è soggetto alla tolleranza tipica del prodotto lapideo.
The bookmatching effect created by placing different slabs together is subject to the usual joint specifications of stone tiles. | L'effet Bookmatch entre différentes dalles est soumis à la tolérance typique du produit en pierre. | Der Effekt des Bookmatching zwischen den verschiedenen Platten unterliegt der typischen Toleranz des Produktes aus Stein.

163x324

64,17"x127,56"

12 mm

Impasto: Bianco
Body: White

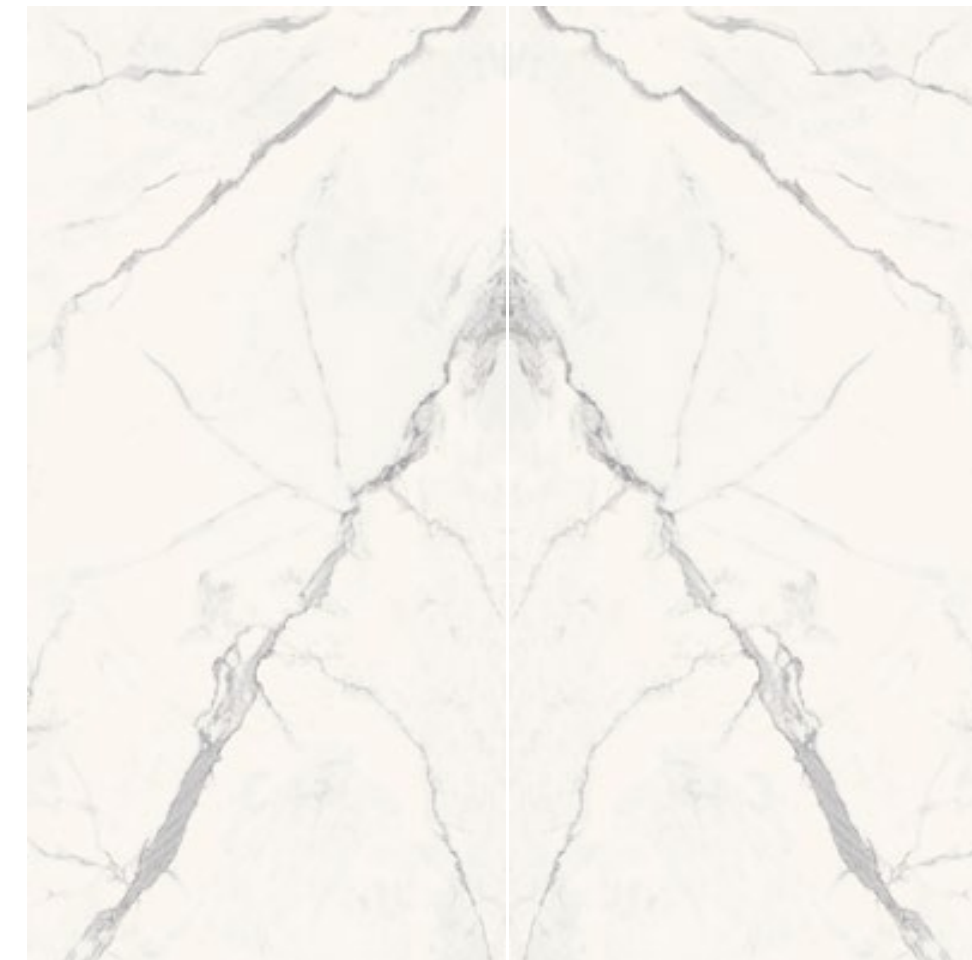

INF433 Calacatta White *honed_A*
INF434 Calacatta White *polished_A*

INF437 Calacatta White *honed_B*
INF438 Calacatta White *polished_B*

2 SURFACES

Honed | Polished

La superficie HONED è una finitura di nuova concezione che risulta più opaca rispetto alla versione POLISHED. Le differenze di lucentezza ed eventuali disomogeneità di aspetto sono quindi da considerare caratteristiche intrinseche di questa superficie.
The HONED surface is a new finish that gives a more matt effect than the POLISHED version. Any differences in shine and appearance are therefore a natural feature of this surface finish.

L'effetto Bookmatch tra le diverse lastre è soggetto alla tolleranza tipica del prodotto lapideo.
The bookmatching effect created by placing different slabs together is subject to the usual joint specifications of stone tiles. | L'effet Bookmatch entre différentes dalles est soumis à la tolérance typique du produit en pierre | Der Effekt des Bookmatching zwischen den verschiedenen Platten unterliegt der typischen Toleranz des Produktes aus Stein

163x324

64,17"x127,56"

12 mm

Impasto: Bianco
Body: White



INF1213 Calacatta Light *honed_12mm_A*
 INF1215 Calacatta Light *polished_12mm_A*
 INF2536 Calacatta Light *natural_12mm_A*
 INF1360 Calacatta Light *polished_20mm_A*
 INF1358 Calacatta Light *natural_20mm_A*

INF1214 Calacatta Light *honed_12mm_B*
 INF1216 Calacatta Light *polished_12mm_B*
 INF2858 Calacatta Light *natural_12mm_B*
 INF1361 Calacatta Light *polished_20mm_B*
 INF1359 Calacatta Light *natural_20mm_B*

3 SURFACES

Honed | Polished | Natural

La superficie HONED è una finitura di nuova concezione che risulta più opaca rispetto alla versione POLISHED. Le differenze di lucentezza ed eventuali disomogeneità di aspetto sono quindi da considerare caratteristiche intrinseche di questa superficie.

The HONED surface is a new finish that gives a more matt effect than the POLISHED version. Any differences in shine and appearance are therefore a natural feature of this surface finish.

L'effetto Bookmatch tra le diverse lastre è soggetto alla tolleranza tipica del prodotto lapideo. The bookmatching effect created by placing different slabs together is subject to the usual joint specifications of stone tiles. | L'effet Bookmatch entre différentes dalles est soumis à la tolérance typique du produit en pierre | Der Effekt des Bookmatching zwischen den verschiedenen Platten unterliegt der typischen Toleranz des Produktes aus Stein

163x324

64,17"x127,56"

12/20 mm

Impasto: Bianco
 Body: White



INF3134 Calacatta Venice *natural_A*
INF3125 Calacatta Venice *polished_A*

INF3135 Calacatta Venice *natural_B*
INF3126 Calacatta Venice *polished_B*

2 SURFACES

Polished | Natural

L'effetto Bookmatch tra le diverse lastre è soggetto alla tolleranza tipica del prodotto lapideo.
The bookmatching effect created by placing different slabs together is subject to the usual joint specifications of stone tiles. | L'effet Bookmatch entre différentes dalles est soumis à la tolérance typique du produit en pierre. | Der Effekt des Bookmatching zwischen den verschiedenen Platten unterliegt der typischen Toleranz des Produktes aus Stein.

163x324

64,17"x127,56"

12 mm

Impasto: Bianco
Body: White



- | | |
|---|---|
| INF448 Calacatta Gold <i>honed_12mm_A</i> | INF452 Calacatta Gold <i>honed_12mm_B</i> |
| INF449 Calacatta Gold <i>polished_12mm_A</i> | INF453 Calacatta Gold <i>polished_12mm_B</i> |
| INF1470 Calacatta Gold <i>natural_12mm_A</i> | INF1471 Calacatta Gold <i>natural_12mm_B</i> |
| INF1372 Calacatta Gold <i>polished_20mm_A</i> | INF1373 Calacatta Gold <i>polished_20mm_B</i> |
| INF1370 Calacatta Gold <i>natural_20mm_A</i> | INF1371 Calacatta Gold <i>natural_20mm_B</i> |
| * INF3263 Calacatta Gold <i>ALL-VEIN polished_20mm_A</i> | * INF3264 Calacatta Gold <i>ALL-VEIN polished_20mm_B</i> |
| * INF3265 Calacatta Gold <i>ALL-VEIN natural_20mm_A</i> | * INF3266 Calacatta Gold <i>ALL-VEIN natural_20mm_B</i> |

3 SURFACES

Honed | Polished | Natural

La superficie HONED è una finitura di nuova concezione che risulta più opaca rispetto alla versione POLISHED. Le differenze di lucentezza ed eventuali disomogeneità di aspetto sono quindi da considerare caratteristiche intrinseche di questa superficie.
The HONED surface is a new finish that gives a more matt effect than the POLISHED version. Any differences in shine and appearance are therefore a natural feature of this surface finish.

L'effetto Bookmatch tra le diverse lastre è soggetto alla tolleranza tipica del prodotto lapideo.
The bookmatching effect created by placing different slabs together is subject to the usual joint specifications of stone tiles. | L'effet Bookmatch entre différentes dalles est soumis à la tolérance typique du produit en pierre. | Der Effekt des Bookmatching zwischen den verschiedenen Platten unterliegt der typischen Toleranz des Produktes aus Stein.

* **Tecnologia con vena passante. Articoli non stuoati.** | Technology for full-body veining. Items without mesh backing. | Technologie avec veinage traversant. Articles sans filet. | Technologie mit durchgehender Ader. Nicht mit Gewebe bewehrte Artikel.

163x324

64,17"x127,56"

12/20 mm

Impasto: Bianco
Body: White



INF2171 Calacatta Macchia Vecchia *polished_A*
INF2853 Calacatta Macchia Vecchia *natural_A*

INF2172 Calacatta Macchia Vecchia *polished_B*
INF2854 Calacatta Macchia Vecchia *natural_B*

2 SURFACES

Polished | Natural

L'effetto Bookmatch tra le diverse lastre è soggetto alla tolleranza tipica del prodotto lapideo.
The bookmatching effect created by placing different slabs together is subject to the usual joint specifications of stone tiles. | L'effet Bookmatch entre différentes dalles est soumis à la tolérance typique du produit en pierre. | Der Effekt des Bookmatching zwischen den verschiedenen Platten unterliegt der typischen Toleranz des Produktes aus Stein.

163x324

64,17"x127,56"

12 mm

Impasto: Bianco
Body: White



INF2522 Super White *polished_A*
INF2157 Super White *natural_A*

INF2523 Super White *polished_B*
INF2158 Super White *natural_B*

2 SURFACES

Polished | Natural

L'effetto Bookmatch tra le diverse lastre è soggetto alla tolleranza tipica del prodotto lapideo.
The bookmatching effect created by placing different slabs together is subject to the usual joint specifications of stone tiles. | L'effet Bookmatch entre différentes dalles est soumis à la tolérance typique du produit en pierre. | Der Effekt des Bookmatching zwischen den verschiedenen Platten unterliegt der typischen Toleranz des Produktes aus Stein.

163x324

64,17"x127,56"

12 mm

Impasto: Bianco
Body: White



INF2418 Calacatta Green *polished_A*

INF2419 Calacatta Green *polished_B*

1 SURFACE

Polished

L'effetto Bookmatch tra le diverse lastre è soggetto alla tolleranza tipica del prodotto lapideo.
The bookmatching effect created by placing different slabs together is subject to the usual joint specifications of stone tiles. | L'effet Bookmatch entre différentes dalles est soumis à la tolérance typique du produit en pierre. | Der Effekt des Bookmatching zwischen den verschiedenen Platten unterliegt der typischen Toleranz des Produktes aus Stein.

163x324

64,17"x127,56"

12 mm

Impasto: Bianco
Body: White



INF1453 Zebbrino *polished_A*

INF1454

Zebbrino *polished_B*

1 SURFACE

Polished

L'effetto Bookmatch tra le diverse lastre è soggetto alla tolleranza tipica del prodotto lapideo.
The bookmatching effect created by placing different slabs together is subject to the usual joint specifications of stone tiles. | L'effet Bookmatch entre différentes dalles est soumis à la tolérance typique du produit en pierre. | Der Effekt des Bookmatching zwischen den verschiedenen Platten unterliegt der typischen Toleranz des Produktes aus Stein.

163x324

64,17"x127,56"

12 mm

Impasto: Bianco
Body: White

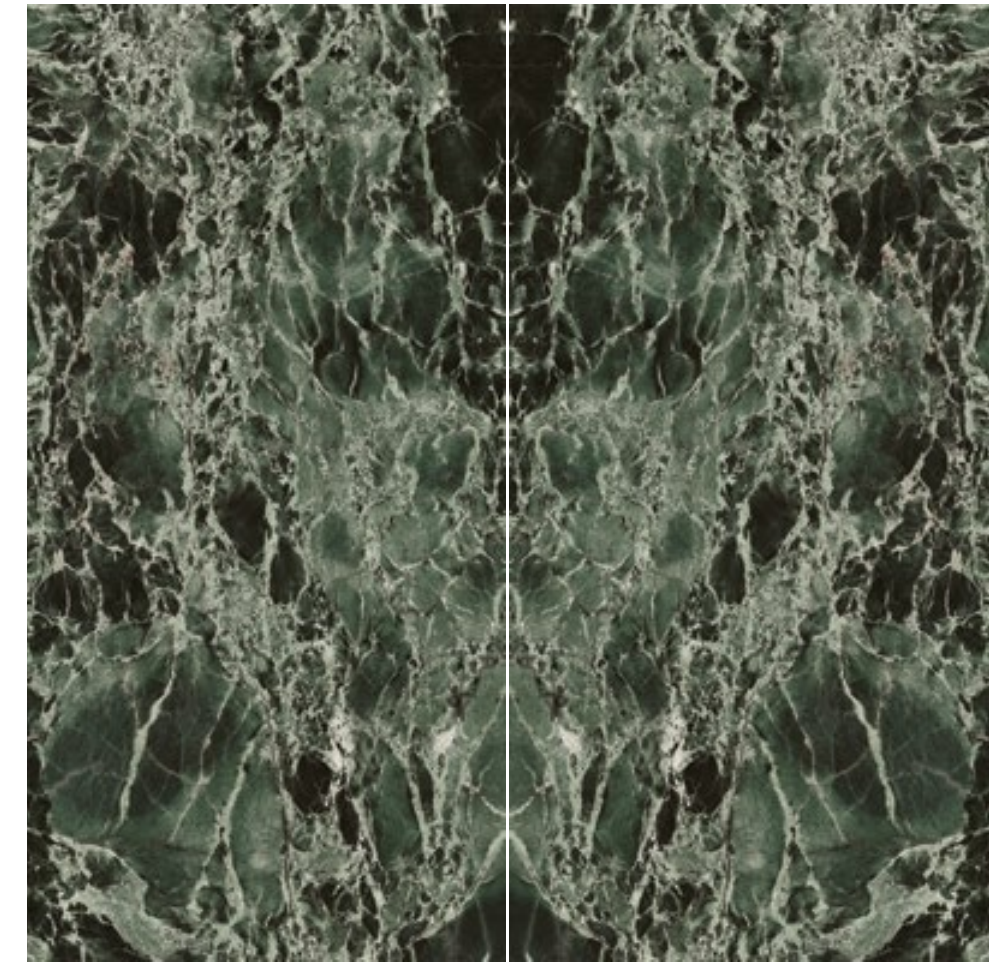
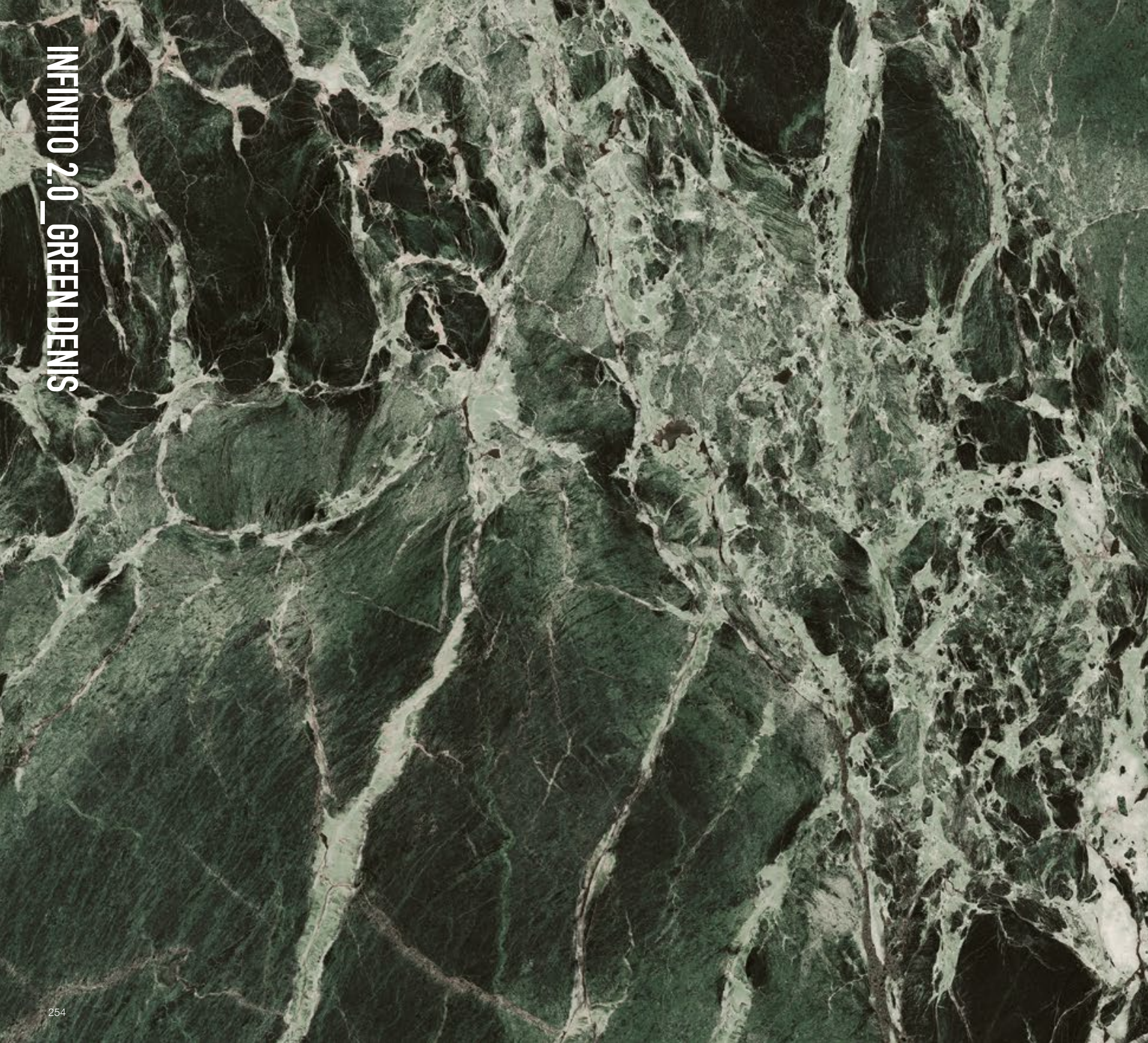

INF2455 Green Denis *polished_A*

INF2456 Green Denis *polished_B*

1 SURFACE

Polished

L'effetto Bookmatch tra le diverse lastre è soggetto alla tolleranza tipica del prodotto lapideo.
The bookmatching effect created by placing different slabs together is subject to the usual joint specifications of stone tiles. | L'effet Bookmatch entre différentes dalles est soumis à la tolérance typique du produit en pierre. | Der Effekt des Bookmatching zwischen den verschiedenen Platten unterliegt der typischen Toleranz des Produktes aus Stein.

163x324

64,17"x127,56"

12 mm

Impasto: Nero
Body: Black

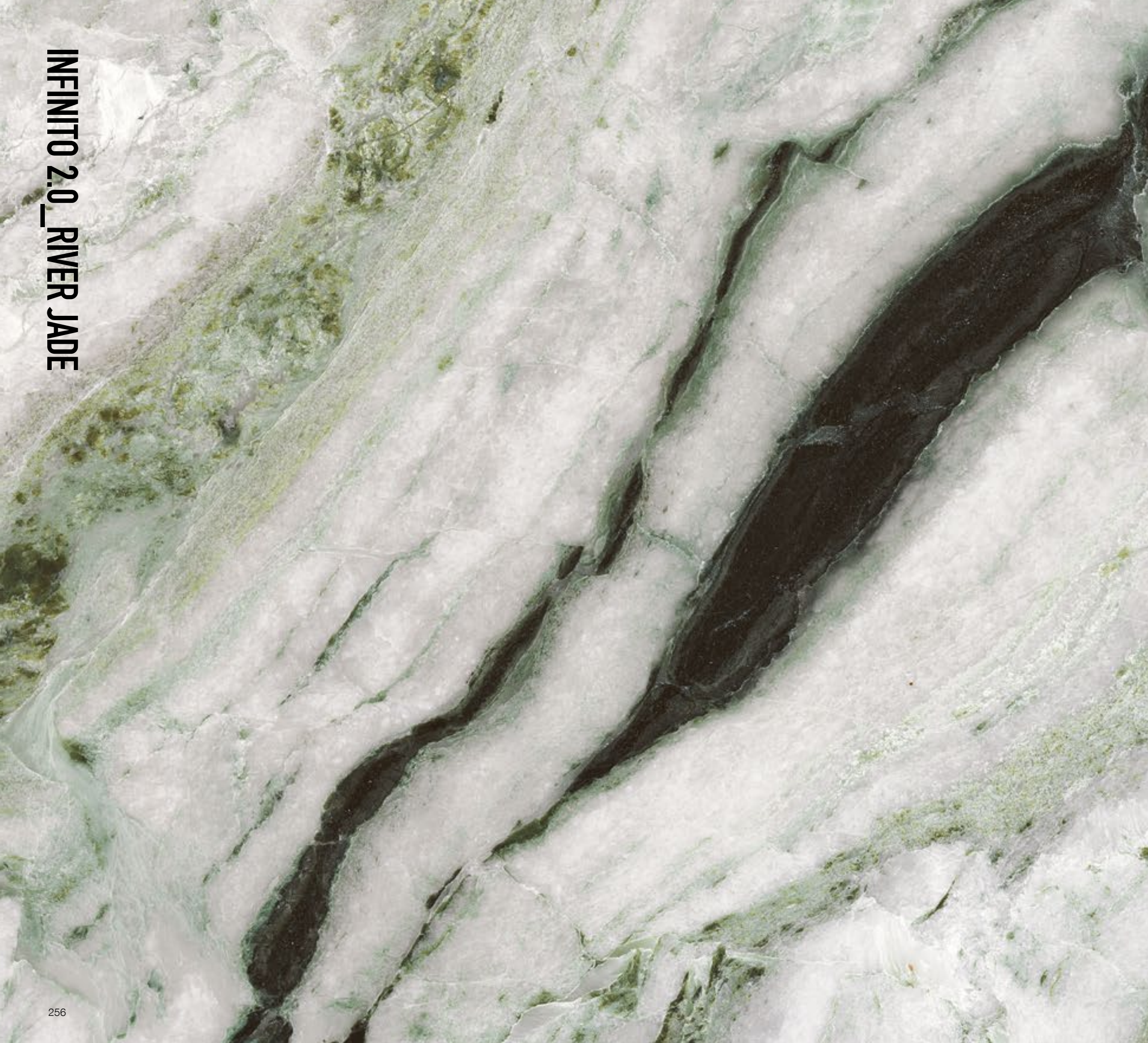

INF2519 River Jade *polished_A*

INF2520 River Jade *polished_B*

1 SURFACE

Polished

L'effetto Bookmatch tra le diverse lastre è soggetto alla tolleranza tipica del prodotto lapideo.
The bookmatching effect created by placing different slabs together is subject to the usual joint specifications of stone tiles. | L'effet Bookmatch entre différentes dalles est soumis à la tolérance typique du produit en pierre. | Der Effekt des Bookmatching zwischen den verschiedenen Platten unterliegt der typischen Toleranz des Produktes aus Stein.

163x324

64,17"x127,56"

12 mm

Impasto: Bianco
Body: White



INF2521 Emerald Green *polished*

1 SURFACE
Polished

163x324
64,17"x127,56"

12 mm

Impasto: Bianco
Body: White



INF2439 Amazonite *polished_A*

INF2440 Amazonite *polished_B*

1 SURFACE

Polished

L'effetto Bookmatch tra le diverse lastre è soggetto alla tolleranza tipica del prodotto lapideo.
The bookmatching effect created by placing different slabs together is subject to the usual joint specifications of stone tiles. | L'effet Bookmatch entre différentes dalles est soumis à la tolérance typique du produit en pierre. | Der Effekt des Bookmatching zwischen den verschiedenen Platten unterliegt der typischen Toleranz des Produktes aus Stein.

163x324

64,17"x127,56"

12 mm

Impasto: Grigio
Body: Grey



INF2306 Blue Roma *honed*
INF2385 Blue Roma *polished*

2 SURFACES

Honed | Polished

163x324

64,17"x127,56"

12 mm

Impasto: Grigio
Body: Grey

La superficie HONED è una finitura di nuova concezione che risulta più opaca rispetto alla versione POLISHED. Le differenze di lucentezza ed eventuali disomogeneità di aspetto sono quindi da considerare caratteristiche intrinseche di questa superficie.

The HONED surface is a new finish that gives a more matt effect than the POLISHED version. Any differences in shine and appearance are therefore a natural feature of this surface finish.

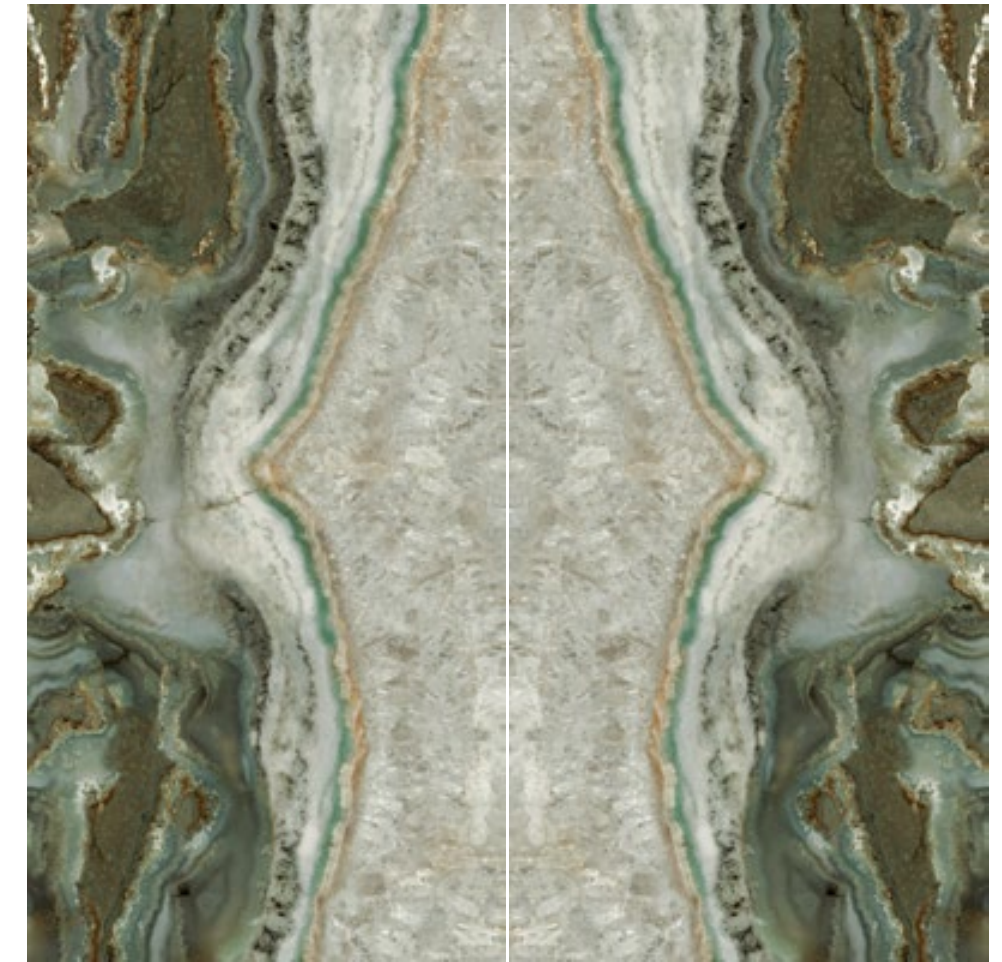
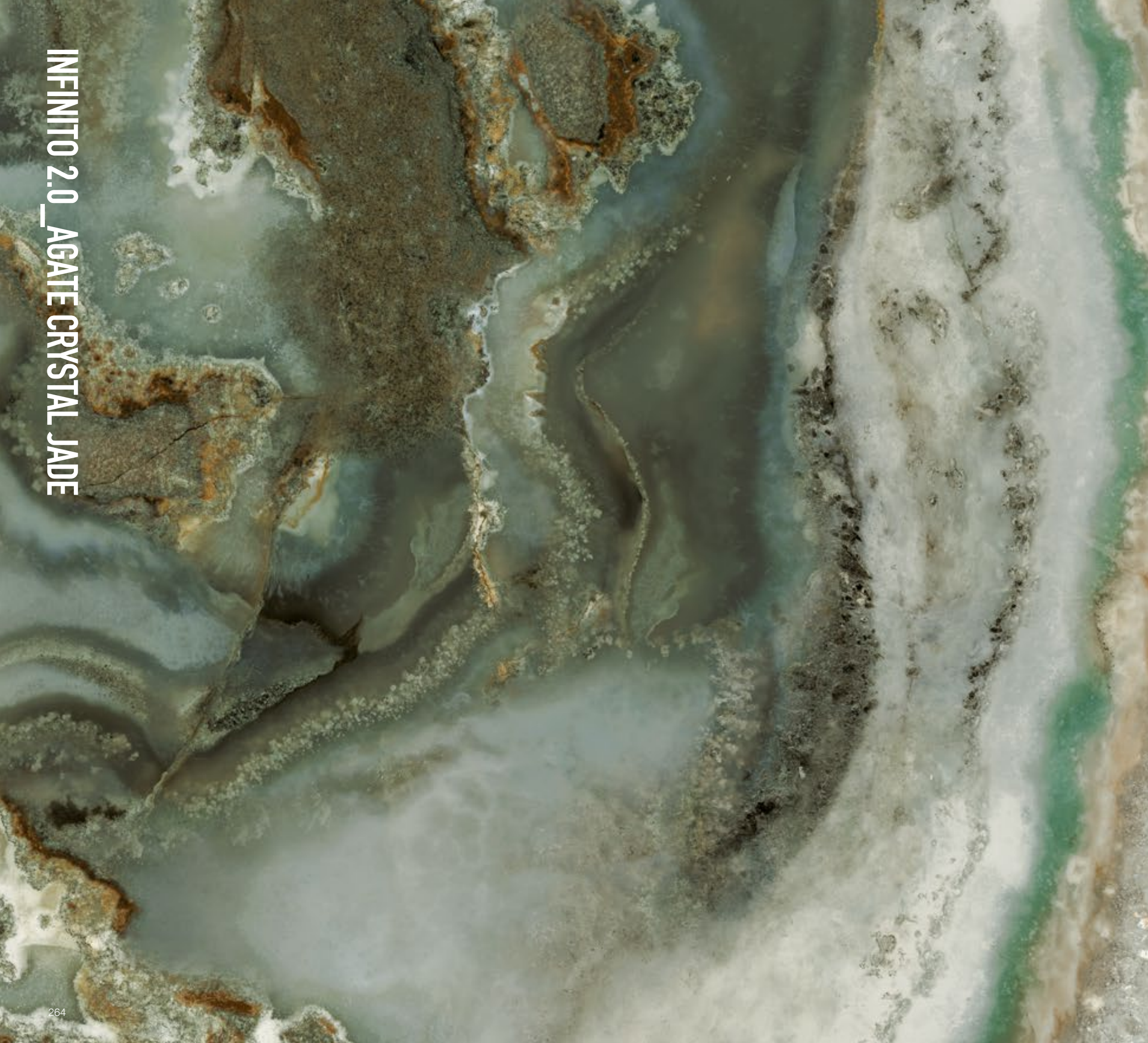

INF2435 Agate Crystal Jade *polished_A*

INF2436 Agate Crystal Jade *polished_B*

1 SURFACE

Polished

L'effetto Bookmatch tra le diverse lastre è soggetto alla tolleranza tipica del prodotto lapideo.
The bookmatching effect created by placing different slabs together is subject to the usual joint specifications of stone tiles. | L'effet Bookmatch entre différentes dalles est soumis à la tolérance typique du produit en pierre. | Der Effekt des Bookmatching zwischen den verschiedenen Platten unterliegt der typischen Toleranz des Produktes aus Stein.

163x324

64,17"x127,56"

12 mm

Impasto: Grigio
Body: Grey

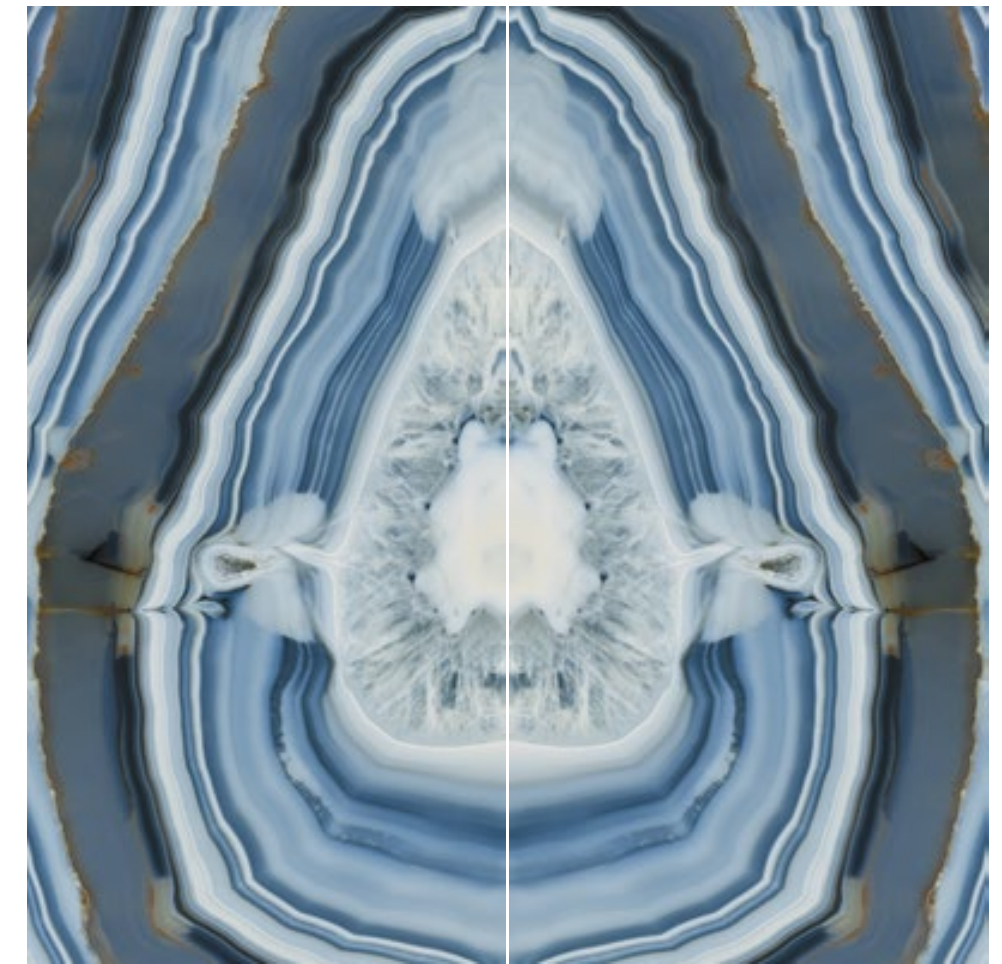
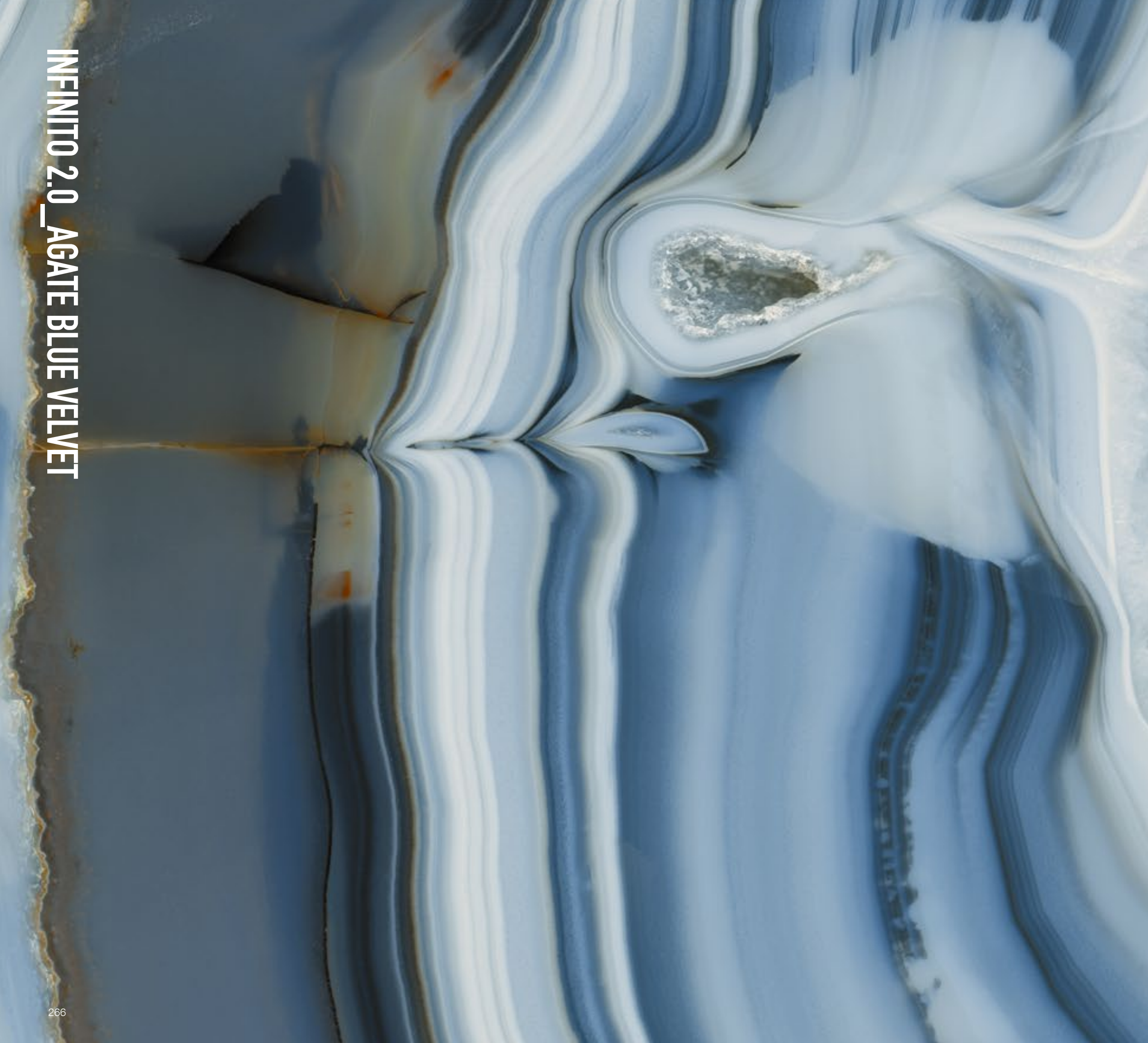

INF2433 Agate Blue Velvet *polished_A*

INF2434 Agate Blue Velvet *polished_B*

1 SURFACE

Polished

L'effetto Bookmatch tra le diverse lastre è soggetto alla tolleranza tipica del prodotto lapideo.
The bookmatching effect created by placing different slabs together is subject to the usual joint specifications of stone tiles. | L'effet Bookmatch entre différentes dalles est soumis à la tolérance typique du produit en pierre. | Der Effekt des Bookmatching zwischen den verschiedenen Platten unterliegt der typischen Toleranz des Produktes aus Stein.

163x324

64,17"x127,56"

12 mm

Impasto: Bianco
Body: White

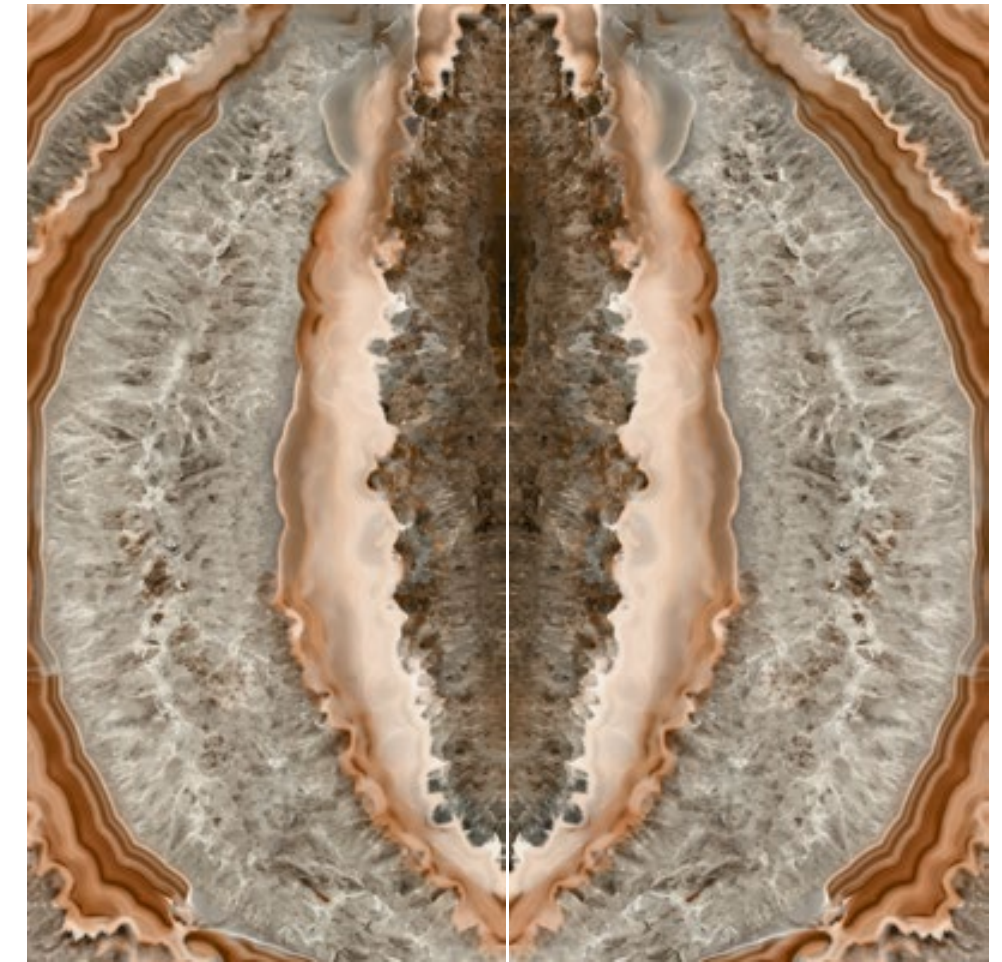
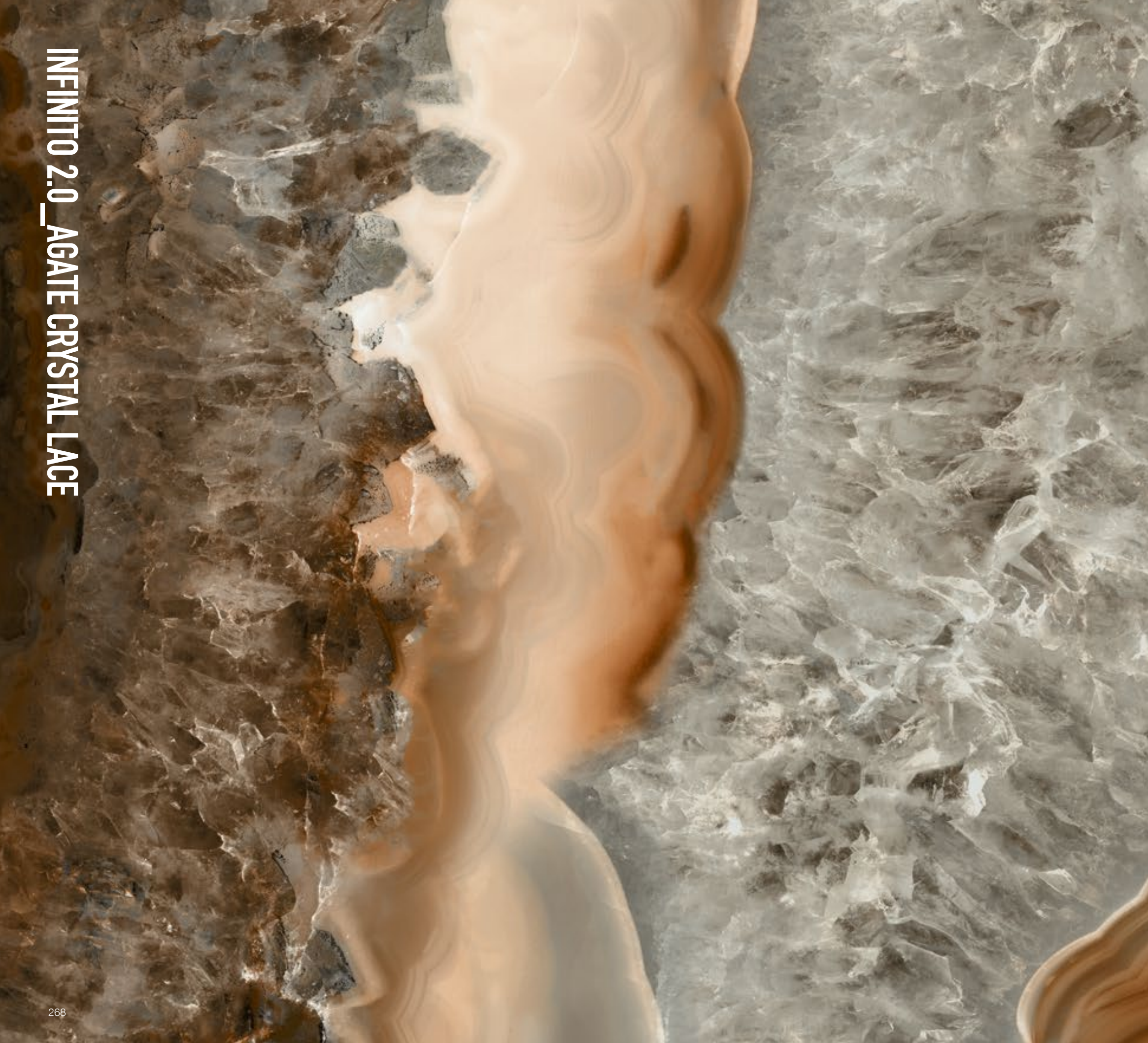

INF2437 Agate Crystal Lace *polished_A*

INF2438 Agate Crystal Lace *polished_B*

1 SURFACE

Polished

L'effetto Bookmatch tra le diverse lastre è soggetto alla tolleranza tipica del prodotto lapideo.
The bookmatching effect created by placing different slabs together is subject to the usual joint specifications of stone tiles. | L'effet Bookmatch entre différentes dalles est soumis à la tolérance typique du produit en pierre. | Der Effekt des Bookmatching zwischen den verschiedenen Platten unterliegt der typischen Toleranz des Produktes aus Stein.

163x324

64,17"x127,56"

12 mm

Impasto: Grigio
Body: Grey

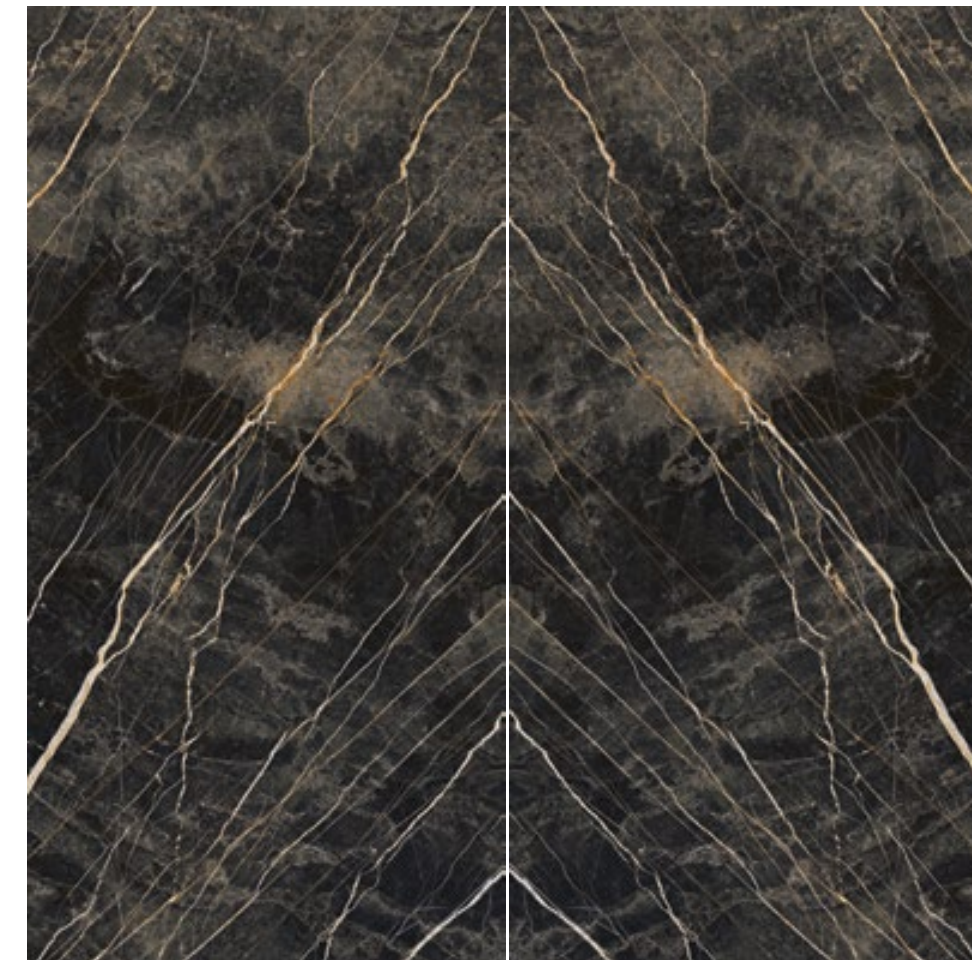

INF2173 Port Laurent *polished_A*

INF2174 Port Laurent *polished_B*

1 SURFACE

Polished

L'effetto Bookmatch tra le diverse lastre è soggetto alla tolleranza tipica del prodotto lapideo.
The bookmatching effect created by placing different slabs together is subject to the usual joint specifications of stone tiles. | L'effet Bookmatch entre différentes dalles est soumis à la tolérance typique du produit en pierre | Der Effekt des Bookmatching zwischen den verschiedenen Platten unterliegt der typischen Toleranz des Produktes aus Stein

163x324

64,17"x127,56"

12 mm

Impasto: Nero
Body: Black



INF2386 Pietra Grey *polished*
INF2260 Pietra Grey *natural*

2 SURFACES

Polished | Natural

163x324

64,17"x127,56"

12 mm

Impasto: Nero
Body: Black



INF482 Sahara Noir *honed*
INF483 Sahara Noir *polished*

2 SURFACES

Honed | Polished

163x324

64,17"x127,56"

12 mm

Impasto: Nero
Body: Black

La superficie HONED è una finitura di nuova concezione che risulta più opaca rispetto alla versione POLISHED. Le differenze di lucentezza ed eventuali disomogeneità di aspetto sono quindi da considerare caratteristiche intrinseche di questa superficie.

The HONED surface is a new finish that gives a more matt effect than the POLISHED version. Any differences in shine and appearance are therefore a natural feature of this surface finish.

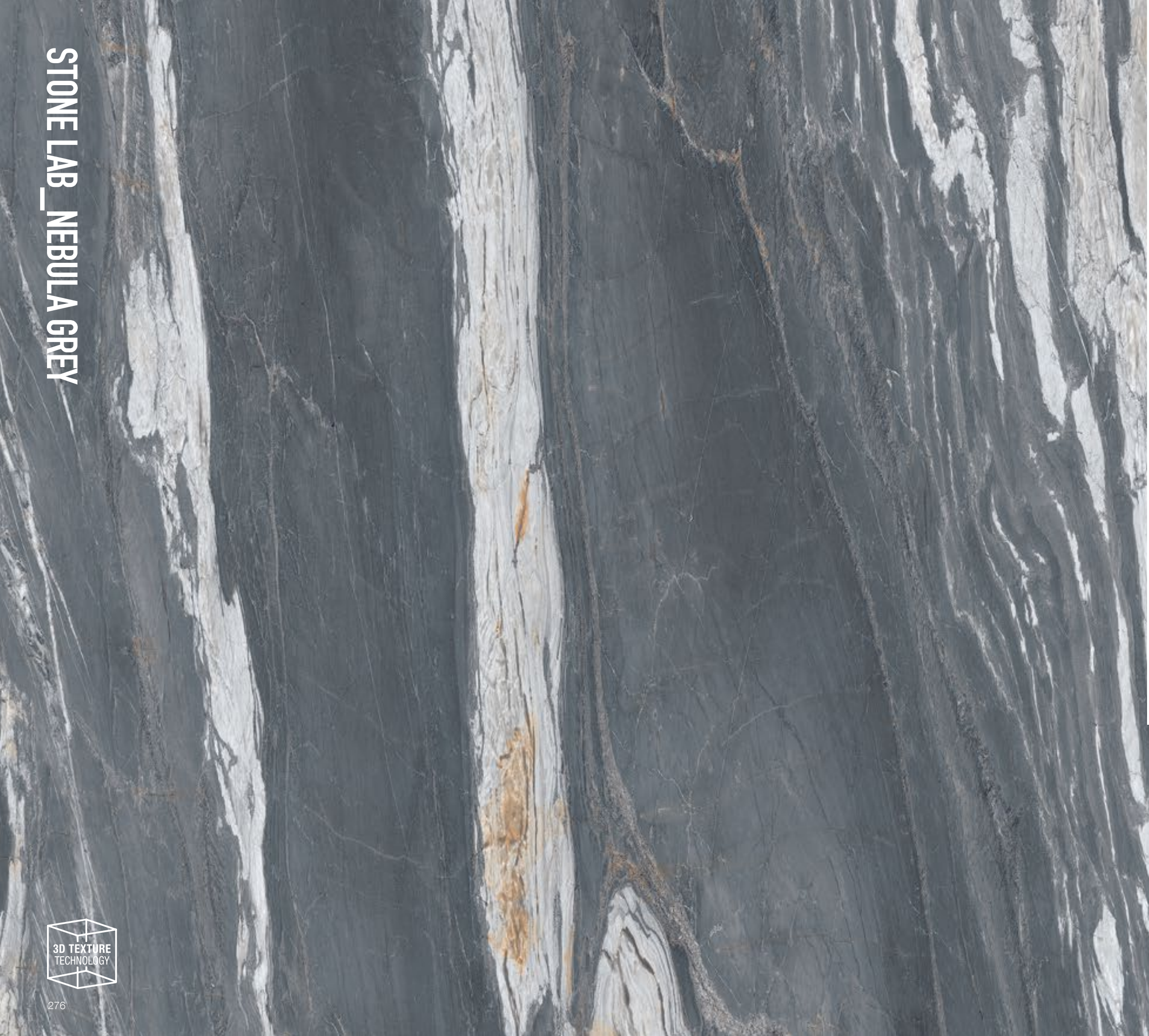

STL225 Nebula Grey Full 3D texture_A

STL228 Nebula Grey Full 3D texture_B

1 SURFACE

Full 3D Texture

163x324

64,17"x127,56"

12 mm

L'effetto Bookmatch tra le diverse lastre è soggetto alla tolleranza tipica del prodotto lapideo.
The bookmatching effect created by placing different slabs together is subject to the usual joint specifications of stone tiles. | L'effet Bookmatch entre différentes dalles est soumis à la tolérance typique du produit en pierre. | Der Effekt des Bookmatching zwischen den verschiedenen Platten unterliegt der typischen Toleranz des Produktes aus Stein.

Impasto: Grigio
Body: Grey



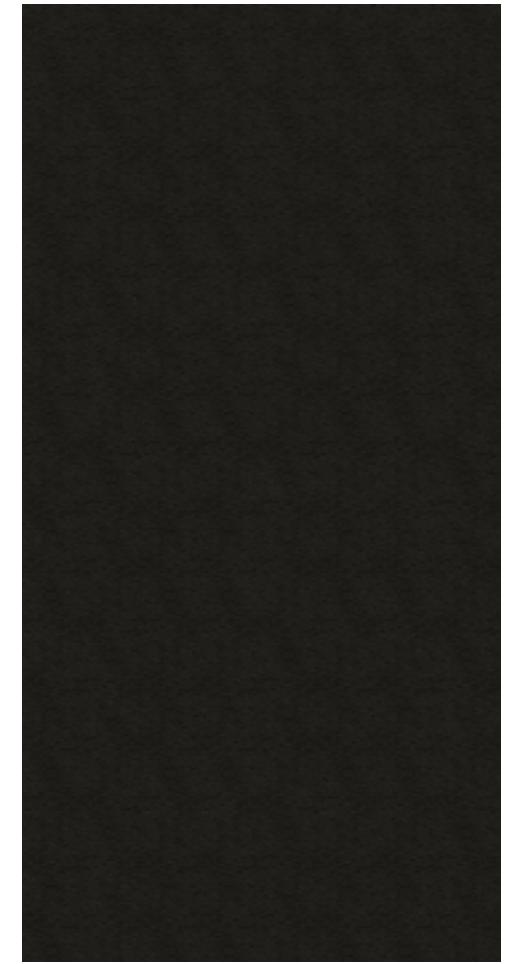

STL137 Nero Zimbabwe *Full 3D texture*

1 SURFACE
Full 3D texture

163x324
64,17"x127,56"

12 mm

Impasto: Nero
Body: Black

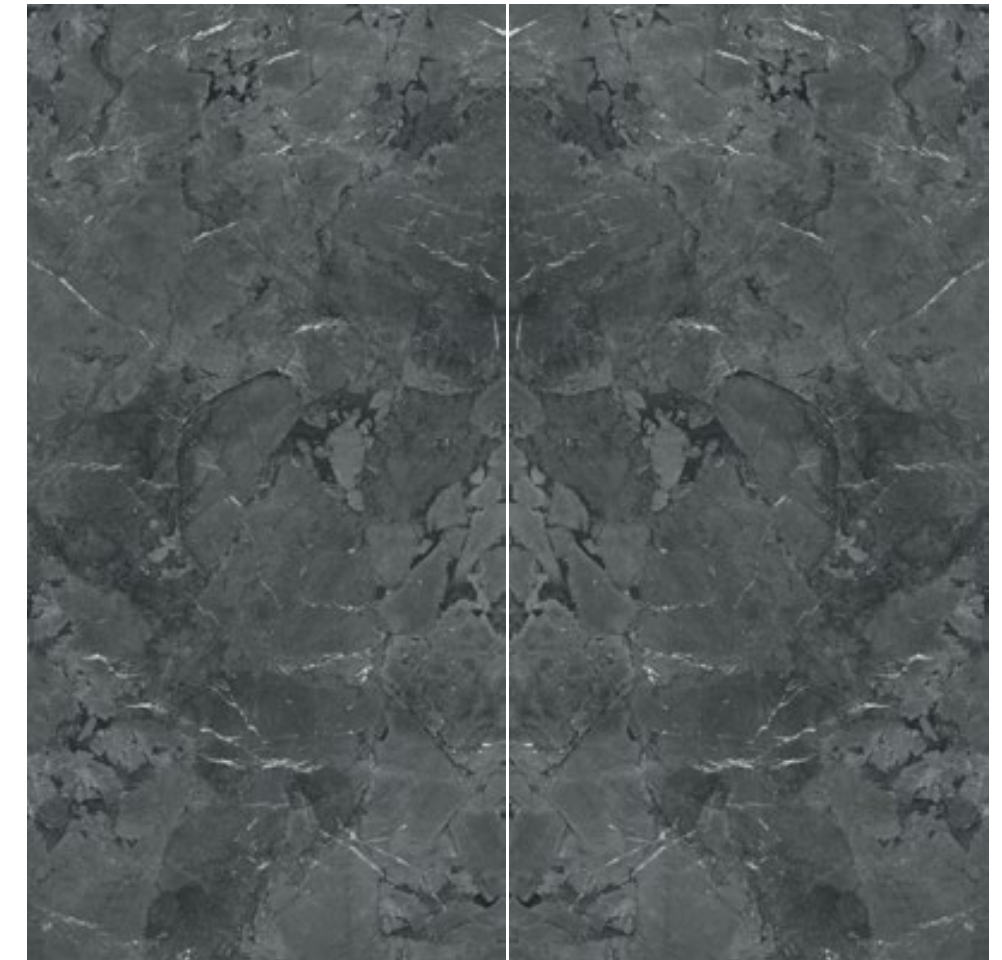

STL144 Negresco 3D texture real matt_A

STL145 Negresco 3D texture real matt_B

1 SURFACE

3D Texture Real Matt

163x324

64,17"x127,56"

12 mm

L'effetto Bookmatch tra le diverse lastre è soggetto alla tolleranza tipica del prodotto lapideo.
The bookmatching effect created by placing different slabs together is subject to the usual joint specifications of stone tiles. | L'effet Bookmatch entre différentes dalles est soumis à la tolérance typique du produit en pierre. | Der Effekt des Bookmatching zwischen den verschiedenen Platten unterliegt der typischen Toleranz des Produktes aus Stein.

Impasto: Nero
Body: Black



STL150 Colorado 3D texture_A

STL151 Colorado 3D texture_B

1 SURFACE

3D Texture

L'effetto Bookmatch tra le diverse lastre è soggetto alla tolleranza tipica del prodotto lapideo.
The bookmatching effect created by placing different slabs together is subject to the usual joint specifications of stone tiles. | L'effet Bookmatch entre différentes dalles est soumis à la tolérance typique du produit en pierre. | Der Effekt des Bookmatching zwischen den verschiedenen Platten unterliegt der typischen Toleranz des Produktes aus Stein.

163x324

64,17"x127,56"

12 mm

Impasto: Beige

Body: Beige



STL130 Travertino Fuscus *real matt*
STL211 Travertino Fuscus *Full 3D texture honed*

2 SURFACES
Real Matt | Full 3D Texture Honed

163x324

64,17"x127,56"

12 mm

Impasto: Beige
Body: Beige





STL053 Travertino Ebur *real matt*
STL208 Travertino Ebur *Full 3D texture honed*

2 SURFACES **163x324**
Real Matt | Full 3D Texture Honed 64,17"x127,56"

12 mm
Impasto: Bianco
Body: White





STL019 Jura White *real matt*

1 SURFACES
Real Matt

163x324
64,17"x127,56"

12 mm

Impasto: Bianco
Body: White



STL021 Chianca *real matt*

1 SURFACES
Real Matt

163x324
64,17"x127,56"

12 mm

Impasto: Bianco
Body: White



STL222 Sikelia Full 3D texture

1 SURFACE
Full 3D Texture

163x324
64,17"x127,56"

12 mm
Impasto: Bianco
Body: White



STL121 Ceppo *real matt*
STL129 Ceppo *Full 3D texture*

2 SURFACES
Real Matt | Full 3D Texture

163x324
64,17"x127,56"

12 mm

Impasto: Grigio
Body: Grey





STL056 Silver Stone *natural_A*

STL057 Silver Stone *natural_B*

1 SURFACE

Natural

L'effetto Bookmatch tra le diverse lastre è soggetto alla tolleranza tipica del prodotto lapideo.
The bookmatching effect created by placing different slabs together is subject to the usual joint specifications of stone tiles. | L'effet Bookmatch entre différentes dalles est soumis à la tolérance typique du produit en pierre. | Der Effekt des Bookmatching zwischen den verschiedenen Platten unterliegt der typischen Toleranz des Produktes aus Stein.

163x324

64,17"x127,56"

12 mm

Impasto: Grigio
Body: Grey



STL020 Slate Black *real matt*

1 SURFACES
Real Matt

163x324
64,17"x127,56"

12 mm

Impasto: Nero
Body: Black

ALPINE LIGHT GREY VEIN



ALP197 Alpine Light Grey Vein 3D texture

1 SURFACES
3D Texture

163x324
64,17"x127,56"

12 mm

Impasto: Beige
Body: Beige



PNT311 Venus *natural*

1 SURFACE
Natural

163x324
64,17"x127,56"

12 mm
Impasto: Bianco
Body: White



PNT314 Jupiter *natural*

1 SURFACE
Natural

163x324
64,17"x127,56"

12 mm

Impasto: Nero
Body: Black



PNT323 Pluto *natural*

1 SURFACE
Natural

163x324
64,17"x127,56"

12 mm

Impasto: Nero
Body: Black



PTL137 Jordan *natural*

1 SURFACE
Natural

163x324
64,17"x127,56"

12 mm

Impasto: Bianco
Body: White



PTL138 Hood *natural*

1 SURFACE
Natural

163x324
64,17"x127,56"

12 mm

Impasto: Grigio
Body: Grey



PTL139 Tabor *natural*

1 SURFACE
Natural

163x324
64,17"x127,56"

12 mm

Impasto: Nero
Body: Black



KOM170 Elegant *natural*

1 SURFACE
Natural

163x324
64,17"x127,56"

12 mm

Impasto: Beige
Body: Beige



KOM171 Original *natural*

1 SURFACE
Natural

163x324
64,17"x127,56"

12 mm

Impasto: Beige
Body: Beige

criteri di 1° scelta | first class
criteria | critères de premier choix |
Kriterien für die 1. Wahl

White Natural

Puntini a contrasto: fino a 5 puntini di dimensioni inferiori a 1 mm e posizionati lontani tra loro almeno 1,5 metri | Contrast spots: up to 5 spots less than 1mm in size and positioned at least 1.5 meters away from each other | Points contrastés : jusqu'à 5 points d'une taille inférieure à 1 mm et placés à une distance d'au moins 1,5 mètre les uns des autres | Kontrastpunkte: bis zu 5 Pünktchen mit einer Größe von weniger als 1 mm und einem Abstand von mindestens 1,5 m zueinander

Fori e spillature: fino a 3 buchi piccoli (si intende spillature di diametro inferiore a 0,3 mm) sparsi, quindi lontani fra loro almeno 1,5 metri | Holes and pin-holes: up to 3 small holes (meaning pin-holes with a diameter of less than 0.3 mm) scattered, therefore at least 1.5 meters away from each other | Trous et trous d'épingle: jusqu'à 3 petits trous (c'est-à-dire des trous d'épingle d'un diamètre inférieur à 0,3 mm) épars, c'est-à-dire espaces d'au moins 1,5 mètre | Löcher und Nadellöcher: bis zu 3 kleine verstreute Löcher (darunter werden Nadellöcher mit einem Durchmesser von weniger als 0,3 mm verstanden), daher mindestens 1,5 m voneinander entfernt

Fino a un solo foro di dimensioni inferiori a 1 mm | Up to a single hole less than 1mm in size | Jusqu'à un seul trou d'une taille inférieure à 1 mm | Bis zu einem einzelnen Loch mit einer Größe von weniger als 1 mm

White Polished

Assenza di graffi da mola, alonature da trattamento e segni di avanzamento | Absence of grindstone scratches, processing halos and feed marks | Absence de rayures réalisées par la meule, d'auréoles dues au traitement et de signes d'avancement | Keine Kratzer durch Schleifsteine, Ränder durch Behandlung und Vorschubzeichen

Puntini a contrasto: fino a 5 puntini di dimensioni inferiori a 1 mm e posizionati lontani tra loro almeno 1,5 metri | Contrast spots: up to 5 spots less than 1mm in size and positioned at least 1.5 meters away from each other | Points contrastés : jusqu'à 5 points d'une taille inférieure à 1 mm et placés à une distance d'au moins 1,5 mètre les uns des autres | Kontrastpunkte: bis zu 5 Pünktchen mit einer Größe von weniger als 1 mm und einem Abstand von mindestens 1,5 m zueinander

Spillature: fino a due di dimensioni inferiori a 0,2 mm, sparse, quindi lontani fra loro almeno 1,5 metri | Pin-holes: up to two less than 0.2 mm in size, scattered, therefore at least 1.5 meters away from each other | Trous d'épingle: jusqu'à deux d'une taille inférieure à 0,2 mm, épars, c'est-à-dire espaces d'au moins 1,5 mètre | Nadellöcher: bis zu zwei verstreute Punkte mit einer Größe von weniger als 0,2 mm und daher mindestens 1,5 m voneinander entfernt

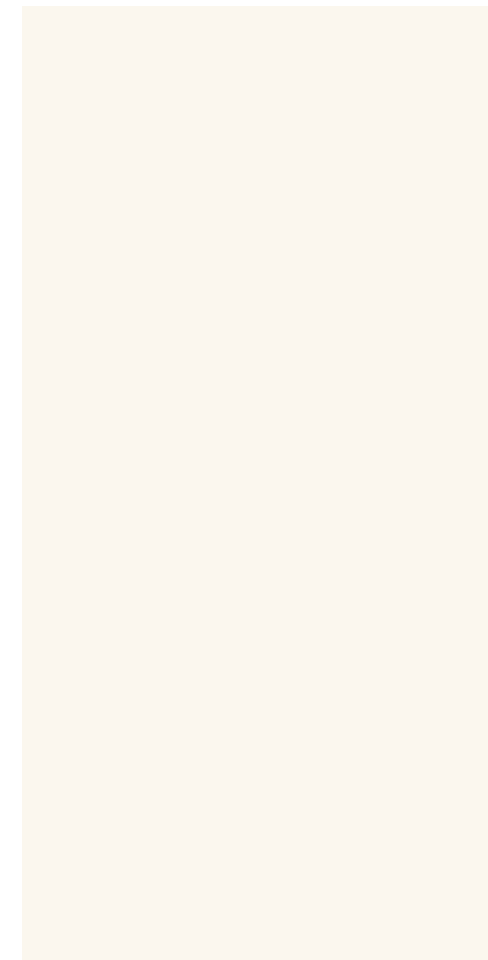

MNC020 White *polished_12mm*

MNC014 White *natural_12mm*

2 SURFACES

Natural | Polished

163x324

64,17"x127,56"

12 mm

Impasto: Bianco

Body: White

criteri di 1° scelta | first class
criteria | critères de premier choix |
Kriterien für die 1. Wahl

Black Natural

Puntini a contrasto: fino a 5 puntini di dimensioni inferiori a 1 mm e posizionati lontani tra loro almeno 1,5 metri | Contrast spots: up to 5 spots less than 1mm in size and positioned at least 1.5 meters away from each other | Points contrastés : jusqu'à 5 points d'une taille inférieure à 1 mm et placés à une distance d'au moins 1,5 mètre les uns des autres | Kontrastpunkte: bis zu 5 Pünktchen mit einer Größe von weniger als 1 mm und einem Abstand von mindestens 1,5 m zueinander

Fori e spillature: fino a 3 buchi piccoli (si intende spillature di diametro inferiore a 0,3 mm) sparsi, quindi lontani fra loro almeno 1,5 metri | Holes and pin-holes: up to 3 small holes (meaning pin-holes with a diameter of less than 0.3 mm) scattered, therefore at least 1.5 meters away from each other | Trous et trous d'épingle: jusqu'à 3 petits trous (c'est-à-dire des trous d'épingle d'un diamètre inférieur à 0,3 mm) épars, c'est-à-dire espacés d'au moins 1,5 mètre | Löcher und Nadellöcher: bis zu 3 kleine verstreute Löcher (darunter werden Nadellöcher mit einem Durchmesser von weniger als 0,3 mm verstanden), daher mindestens 1,5 m voneinander entfernt

Fino a un solo foro di dimensioni inferiori a 1 mm | Up to a single hole less than 1mm in size | Jusqu'à un seul trou d'une taille inférieure à 1 mm | Bis zu einem einzelnen Loch mit einer Größe von weniger als 1 mm



MNC018 Black *natural_12mm*

1 SURFACE

Natural

163x324

64,17"x127,56"

12 mm

Impasto: Nero
Body: Black

Effetto Marmo | Marble Effect
INFINITO 2.0

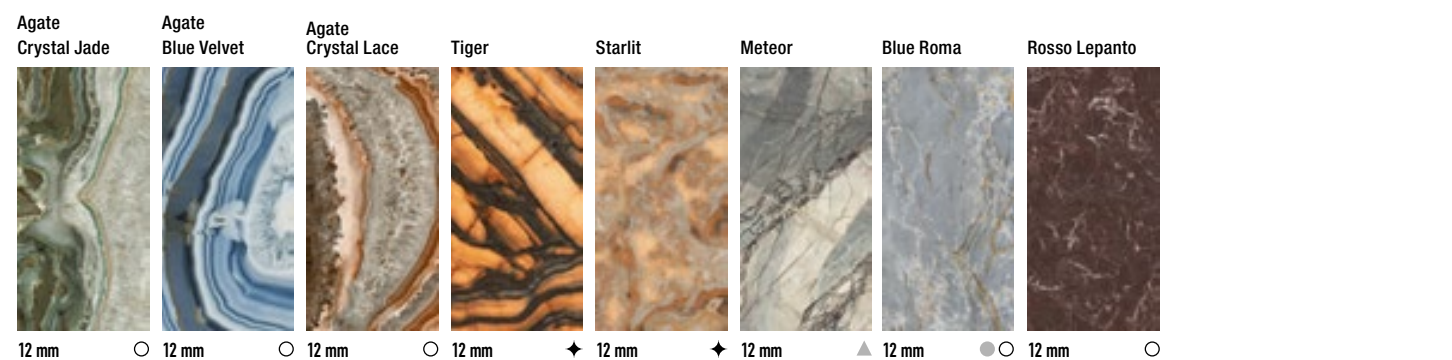
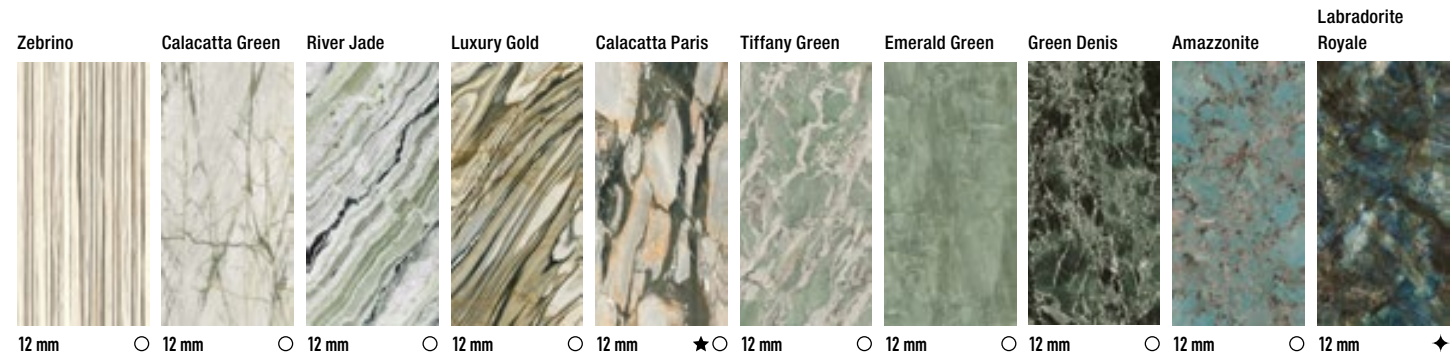

Effetto Pietra | Stone Effect
STONE LAB

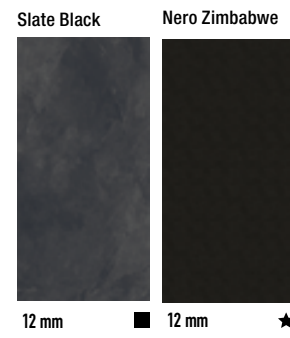
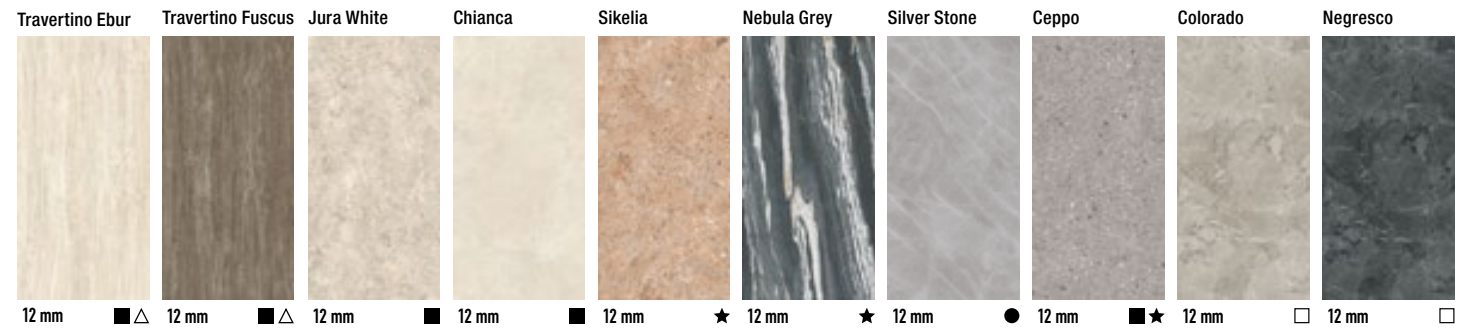

Effetto Cemento | Concrete Effect
PORTLAND

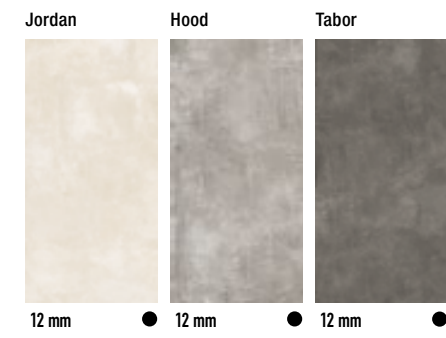

Effetto Legno | Wood Effect
KOMI

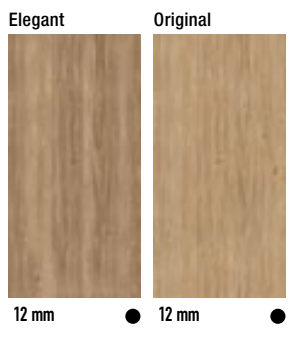

Effetto Pietra | Stone Effect
PLANETO

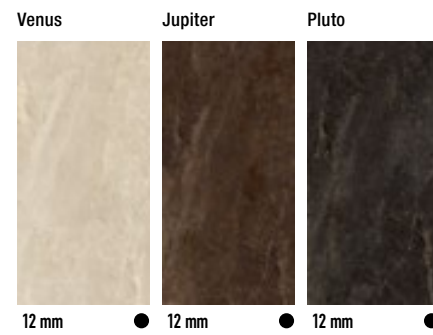

Effetto Pietra | Stone Effect
ALPINE



Effetto Monocromatico | Monochromatic Effect
MONOCHROME

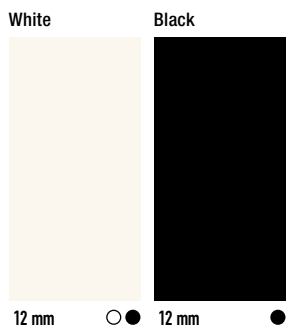

SURFACES

- Natural
- Honed
- Polished
- ▲ Crystal Polished
- ◆ ALL-LIGHT Polished
- Real Matt
- 3D Texture
- ▲ Full 3D Texture Polished
- △ Full 3D Texture Honed
- ★ Full 3D Texture
- ∧ ALL - VEIN

Tutte le lastre Mytop in 12 e 20 mm (ad esclusione degli articoli ALL-VEIN) sono rinforzate strutturalmente con una stuoia in fibra di vetro applicata sul retro con apposito collante.

All the 12 mm and 20 mm thick MyTop slabs (except ALL-VEIN items) are structurally reinforced with a fibreglass mesh applied to the rear with a specific adhesive.

Toutes les dalles MyTop de 12 mm et 20 mm (à l'exclusion des articles ALL-VEIN) sont renforcées structurellement par un filet en fibre de verre appliqué au dos avec une colle spéciale.

Alle Platten aus der Kollektion MyTop in der Materialstärke 12 mm und 20 mm (außer der Artikel ALL-VEIN) sind mit Glasfasergewebe bewehrt, das mit Spezialklebstoff auf die Rückseite geklebt ist.

TECH INFO

CARATTERISTICHE TECNICHE

IMBALLI LASTRE

Slabs packaging | Emballages dalles | Verpackungen der Platten

INFORMAZIONI GENERALI

General information | Informations générales | Allgemeine Informationen

Lastre Mytop di Fondovalle 12 e 20 mm.

Superficie utile: 1630x3240 mm_ 64,17"x127,56" | Spessore nominale: 12 mm.

Fondovalle's 12 and 20-mm-thick MyTop slabs.

Usable surface area: 1630x3240 mm_ 64.17"x127.56" | Rated thickness: 12 mm.

Dalles Mytop de Fondovalle 12 et 20 mm.

Surface utile : 1630x3240 mm_ 64,17"x127,56" | Épaisseur nominale : 12 mm.

Platten Mytop von Fondovalle 12 und 20 mm.

Nutzbare Oberfläche: 1630x3240 mm_ 64,17"x127,56" | Nennstärke: 12 mm.

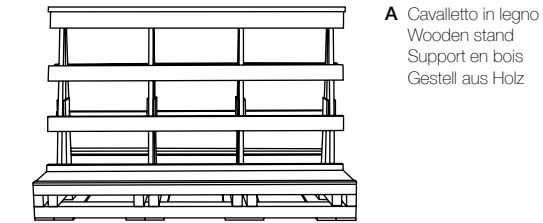

A Cavalletto in legno
Wooden stand
Support en bois
Gestell aus Holz

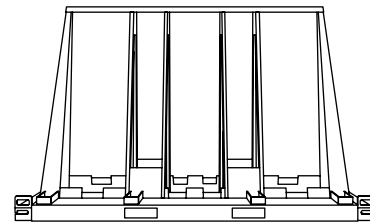

B Cavalletto in metallo
Metal A-frame
Support en métal
Gestell aus Metall

Formato Cavalletto A-frame size Format Support Ständer format			Peso Cavalletto A-frame weight Poids de Support Leergewicht der Ständer			Formato Lastre Slab size Format Dalles Fliesenformat		Pezzi Pieces Pièces Stücke	m ²	m ² / pcs.	Kg / pcs.	Kg / m ²	Peso Totale Total weight Poids total Leergewicht gesamt
CAV001 330x75x196 cm 130"x30"x78"	CAV006 330x75x196,8 cm 130"x30"x78"	CAV011 338,6x75x185,7 cm 133"x30"x73"	CAV001 133 Kg 294 lb	CAV006 166 Kg 365 lb	CAV011 123 Kg 271 lb	163x324 cm 64,17"x127,56"	12 mm 22	116,1864	5,2812	151,11	28,62	3325 Kg + 189 Kg	
							20 mm 12	63,38	5,2812	253,44	47,99	3041,28 Kg + 189 Kg	

COMPOSIZIONE CARICO

Load layout | Composition du chargement | Zusammensetzung der Bestandteile

EXAMPLES

Container 20' 163x324 - 12 mm

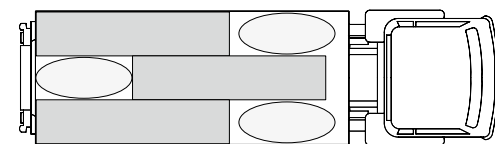

Container 40' 163x324 - 12 mm

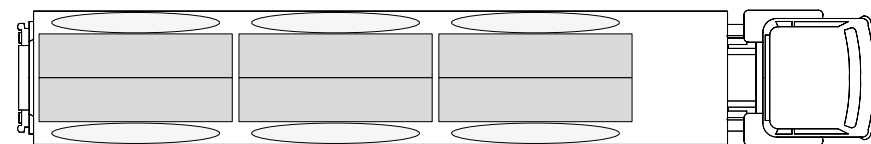

Truck 2,4x13 - 163x324 - 12 mm (es. Truck 30 Ton.)

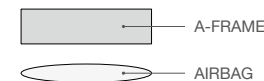
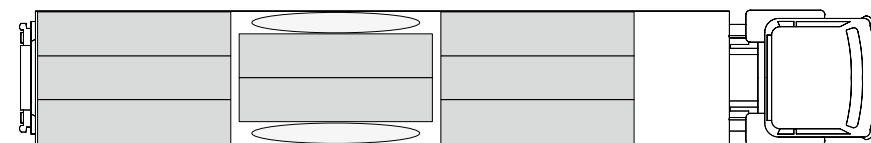

COMPARAZIONE

Comparisons | Comparaison | Vergleich

	MyTop Honed Natural Real Matt 3D Texture	MyTop Polished Crystal Polished	Agglom. Quarzo Quartz agglomerates Agréats Quartz Zusammensetzun- gen von Quarz	Laminati e Legno Laminates and Wood Laminés et Bois Laminate und Holz	Solid Surface Solid Surface Solid Surface	Pietre Naturali Natural Stones Pierres Naturelles Natursteine	Acciaio Steel Acier Stahl
Igienico Hygienic Hygiénique Hygienisch	•••	•••	•••	•	•••	•	•••
Non poroso Non porous Non poreux Unporös	•••	•••	•••	•	•••	•	•••
Idoneo all'uso in ambiente esterno Suitable for use outdoors Indiqué pour l'extérieur Geeignet zur Verwendung im Freien	•••	•••	•	•	••	••	••
Resistente al calore e alle alte temperature Resistant to heat and high temperatures Résistant à la chaleur et aux hautes températures Beständig gegenüber Wärme und hohen Temperaturen	•••	•••	••	•	•	••	•••
Resistente a funghi e muffe Resistant to mould, mildew, and fungus Résistante aux champignons et en moisissures Beständig gegenüber Pilzen und Schimmel	•••	•••	•••	••	•••	•	•••
Resistente alle macchie Stainproof Résistante aux taches Beständig gegenüber Flecken	•••	••	••	••	••	•	•••
Resistente ai detergenti Detergent-resistant Résistant aux détergents Beständig gegenüber Reinigungsmitteln	•••	••	••	••	•	•	•
Resistenza all'attacco chimico Chemical resistance Resistance a l'attaque chimique Beständigkeit gegen chemikalien	•••	••	••	•	••	•	••
Resistenza agli sbalzi termici Resistance to thermal shock Résistance aux écarts de température Temperaturwechselbeständigkeit	•••	•••	••	•	••	•••	•••
Resistenza al gelo Frost resistance Résistance au gel Frostbeständigkeit	•••	•••	•••	•	•	••	•••
Resistenza a umidità Dampness resistance Résistance à l'humidité Beständigkeit gegenüber Feuchtigkeit	•••	•••	•••	•	•••	•	•••
Resistente ai raggi U.V. UV-resistant Résistante aux rayons UV Beständig gegenüber UV-Strahlen	•••	•••	••	•	•	••	•••
Facile da pulire Easy to clean Facile à nettoyer Leicht zu reinigen	•••	•••	•••	••	••	•	•

BORDI

Edges | Bords | Kanten

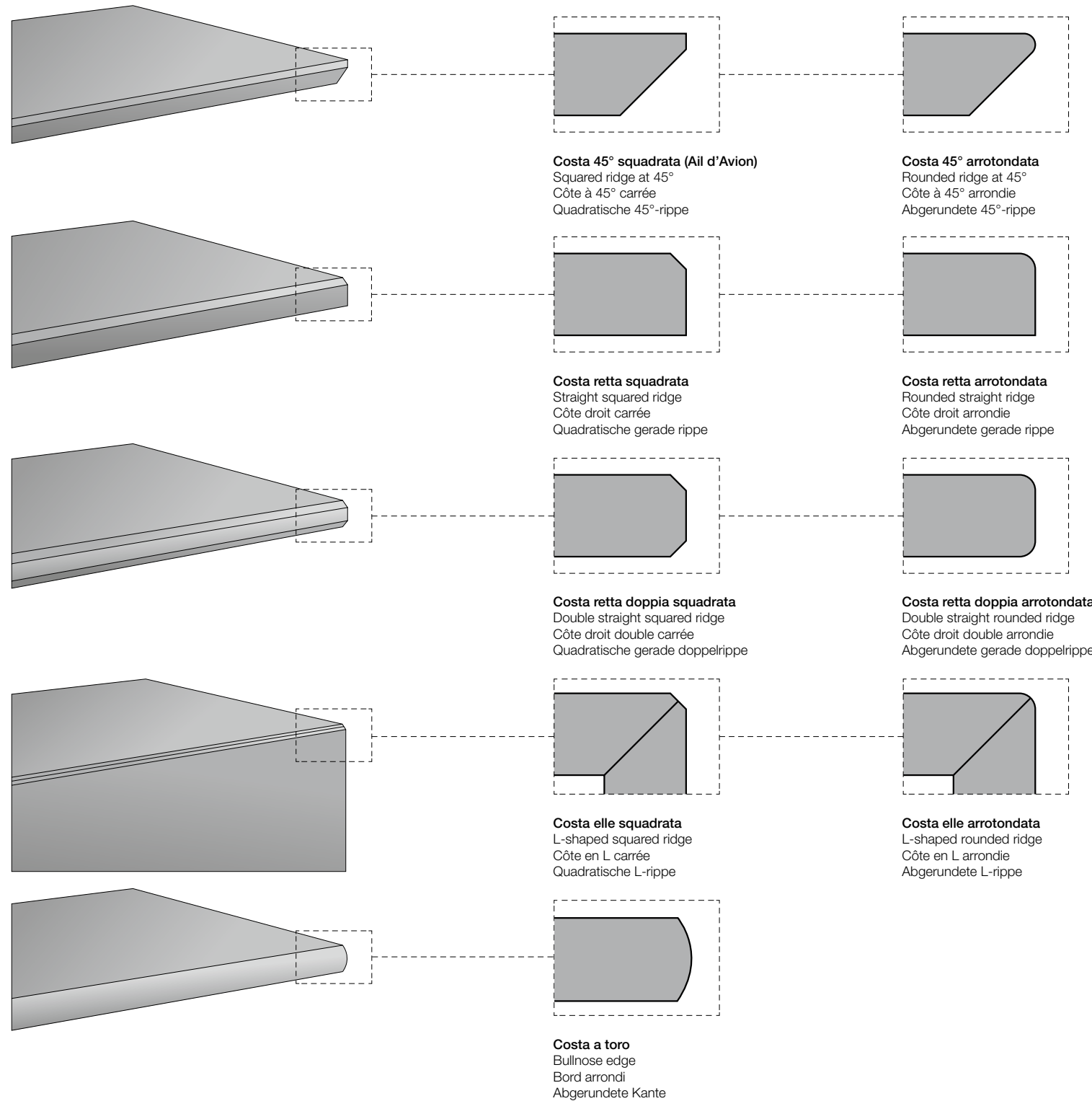

Le lastre MyTop, grazie alla pienezza degli spessori, possono essere lavorate nei bordi con diverse finiture, adattandosi a nuove soluzioni di mobili e arredi per bagni e cucine: spigoli arrotondati o inclinati a 45°, volumi dall'aspetto monolitico spessorati, realizzati tramite l'accostamento di 2 lastre tagliate a 45°. La lavorazione degli spigoli viene solitamente eseguita con utensili e macchinari comunemente usati nella lavorazione delle pietre naturali e del vetro, quali dischi diamantati o le più evolute macchine a controllo numerico. Le stesse lavorazioni si applicano nel design dei lavelli per bagno e cucina: integrati con il piano a scomparsa totale, con i bordi squadrate e bisellati, a filo top o in appoggio con profili smussati.

Due to their throughout-the-body features, MyTop slabs can be machined on the edges with different finishes, which makes them ideal for the creation of new furniture and design solutions for bathrooms and kitchens. Rounded or with 45° bevelled edges, furnishings seemingly fashioned from a single block can be created by fitting two slabs together with a mitre joint. Edge machining is usually done with tools and machines commonly used in natural stone and glass working, such as diamond disks or the most advanced numerically controlled machines. The same machining is used in the design of bathroom washbasins and kitchen sinks, for either undermount versions, with squared and bevelled edges bisellati, models fitted flush with the top, or overmount versions with chamfered edges.

Grâce à la plénitude des épaisseurs, on peut soumettre les bords des dalles MyTop à différentes finitions, en les adaptant à de nouvelles solutions de meubles et de décorations pour les salles de bains et les cuisines : des arêtes arrondies ou inclinées à 45°, des volumes monolithiques d'une l'épaisseur majorée, réalisés en joignant 2 dalles coupées à 45°. Le travail des arêtes est généralement réalisé avec des outils et des machines communément utilisés pour le travail des pierres naturelles et du verre, comme les disques diamantés et les machines plus évoluées à contrôle numérique. On traite de la même manière le design et les lavabos pour salles de bains et cuisine, intégrés au plan est entièrement escamotable, avec des bords équarris et biseautés, au ras du dessus ou en appui avec des profils chanfreinés.

Die Platten MyTop können aufgrund der massiven Stärken an den Rändern mit verschiedenen Ausführungen versehen werden, wodurch sie sich neuen Lösungen von Möbeln und Einrichtungselementen für Badezimmer und Küchen anpassen: abgerundete oder auf 45° abgeschrägte Kanten, Volumen mit monolithischem Aussehen, hergestellt durch Anlegen von 2 Platten mit Schnitt auf 45°. Die Bearbeitung der Kanten erfolgt gewöhnlich mit Werkzeugen und Maschinen, die im Allgemeinen bei der Bearbeitung von Naturstein und Glas zum Einsatz kommen, wie Diamantscheiben oder die am weitesten entwickelten Maschinen mit numerischer Steuerung. Die gleichen Bearbeitungen kommen beim Design der Waschbecken für Bad und Küche zur Anwendung: in die Platte vollkommen eingelassen, mit rechteckigen und gekehrten Rändern, bündig zum Top oder aufliegend mit gefasteten Profilen.

FINITURE RICERCATE E CONCEPT INNOVATIVI

Sophisticated finishes and innovative concepts
Des finitions raffinées et des concepts innovants
Auserlesene Ausführungen und innovative Concepts

SCHEDE TECNICHE SETTORE ARREDO

Technical specifications furniture industry | Spécifications techniques-secteur ameublement | Technische Datenblätter – Bereich Einrichtung



	Valore Fondovalle Fondovalle values Valeur Fondovalle Fondovalle Werte	Norma / Metodo Norms / Test method Norme / méthode d'essai Norm / Methode	
	Natural / Real Matt / 3D Texture 12 mm - 20 mm	Honed / Polished / 3D Texture Honed / 3D Texture Polished / Crystal Polished 12 mm - 20 mm	
Densità Density Densité Dichte	2500 kg/m³ valore medio average value	2500 kg/m³ valore medio average value	EN 14617-1 ASTM C97
Assorbimento d'acqua Water Absorption Absorption d'eau Wasseraufnahme	0,1 % valore medio average value	0,1 % valore medio average value	EN 14617-1
Resistenza alla flessione Bending strength Resistance a la flexion Biegezugfestigkeit	50 MPa valore medio average value	50 MPa valore medio average value	EN 14617-2
Resistenza al gelo Frost resistance Résistance au gel Frostbeständigkeit	Resiste Resistant	Resiste Resistant	EN 14617-5
Resistenza al calore secco Dry heat resistance Résistance à la chaleur Sèche Beständigkeit gegenüber trockener Wärme	5 Nessun effetto visibile fino a 200°C No visible effect till 200°C	5 Nessun effetto visibile fino a 200°C No visible effect till 200°C	EN 12722 EN 438-2 par.16
Resistenza all'attacco chimico Chemical resistance Resistance a l'attaque chimique Beständigkeit gegen chemikalien	Da classe A a B From class A to B	Da classe A a C From class A to C	ISO 10545-13
	Resiste Resistant	Resiste (eccetto idrossido di potassio) Resistant (except potassium hydroxide)	ASTM C650
Resistenza ai liquidi freddi Cold liquid resistance Résistance aux liquides froids Beständigkeit gegenüber kalten Flüssigkeiten	5 Nessun effetto visibile tranne inchiostro (2) No visible effect except ink (2)	Da classe 5 a 2 From class 5 to 2	EN 12720
Resistenza ai prodotti di pulizia Cleaner product resistance Résistance aux produits de nettoyage Beständigkeit gegenüber Reinigungsmitteln	5 Nessun effetto visibile No visible effect	Da classe 5 a 3 From class 5 to 3	PTP 53 CATAS
Hygiene properties Hygiene properties Qualités hygiéniques Hygieneeigenschaften	Ottima (grado di rimozione dei batteri >99% dopo pulizia con detergente non battericida) Excellent (high degree of removal of bacterial cells >99% after cleaning with a biocide-free detergent)	Ottima (grado di rimozione dei batteri >99% dopo pulizia con detergente non battericida) Excellent (high degree of removal of bacterial cells >99% after cleaning with a biocide-free detergent)	Metodo CATAS
Resistenza ai funghi Resistance to fungus Résistance aux champignons Beständigkeit gegenüber Pilzen	Nessuna crescita fungina No fungal growth	Nessuna crescita fungina No fungal growth	ASTM G21
Cessione piombo e cadmio Lead and cadmium given off Libération plomb et cadmium Abgabe von Blei und Kadmium	0 mg / dm³	0 mg / dm³	ISO 10545-15
Migrazione globale Overall migration Migration globale Globale Migration	0 mg/dm² nessuna migrazione significativa 0 mg/dm² no significant migration	0 mg/dm² nessuna migrazione significativa 0 mg/dm² no significant migration	UNI EN 1186
Emissione VOC VOC emission Emission VOC Emission von VOC	classe A+ francese class A+ French	classe A+ francese class A+ French	UNI EN 16000-9
Resistenza alla luce Light resistance Résistance à la lumière Beständigkeit gegenüber Licht	5 Nessun effetto visibile No visible effect	5 Nessun effetto visibile No visible effect	UNI EN 15187
Resistenza allo shock termico Thermal shock resistance Résistance aux écarts de température Temperaturwechselbeständigkeit	Resiste Resistant	Resiste Resistant	EN 14617-6
Resistenza alle macchie Resistance to staining Résistance aux taches Fleckbeständigkeit	Resiste Resistant	Resiste (nessun effetto visibile tranne inchiostro e blu di metilene) Resistant (except ink and methylene blue)	ASTM C1378

CARATTERISTICHE TECNICHE

Technical characteristics | Caracteristiques technique | Technische eigenschaften

COMPLIANCE FOR
FOOD CONTACT
MATERIAL
(Conformità MOCA)



	Metodo di prova Test method Méthode d'essai Prüfmethode	Requisiti prescritti Required value Valeur requise Vorgeschriebener Wert	Risultato Results Résultat Ergebnis	Valutazione Valuation Évaluation Bewertung		
			MyTop 12 mm	MyTop 20 mm		
Lunghezza e larghezza Length and width Longueur et largeur Länge und Breite	UNI EN ISO 10545-2	± 0,6% ± 2 mm	± 0,6% ± 0,9 mm	± 0,6% ± 0,9 mm	Conforme Compliant	
		Spessore Thickness Epaisseur Stärke 12 mm - 20 mm . 4,72"-7,87"	± 5% ± 0,5 mm	± 3% ± 0,5 mm	± 3% ± 0,5 mm	Conforme Compliant
		Rettilineità degli spigoli Edge straightness Rectitude des arêtes Rechtlinigkeit der Kanten	± 0,5% ± 1,5 mm	± 0,5% ± 1,5 mm	± 0,5% ± 1,5 mm	Conforme Compliant
		Ortogonalità Rectangularity Orthogonalité Rechtwinkligkeit	± 0,5% ± 2 mm	± 0,5 % ± 2 mm	± 0,5 % ± 2 mm	Conforme Compliant
		Planarità Planarity Planéité Rechtwinkligkeit	± 0,5% ± 2 mm	± 0,5 % ± 2 mm	± 0,5 % ± 2 mm	Conforme Compliant
		Qualità della superficie Surface quality Qualité de la surface Oberflächenqualität	≥ 95%	Conforme Compliant	Conforme Compliant	Conforme Compliant
Assorbimento d'acqua Water Absorption Absorption d'eau Wasseraufnahme	UNI EN ISO 10545-3	≤ 0,5%	≤ 0,1%	Conforme Compliant	Conforme Compliant	
	ASTM C373	≤ 0,5%	≤ 0,1%	Conforme Compliant	Conforme Compliant	
Resistenza alla flessione Bending strength Resistance a la flexion Biegezugfestigkeit 400x800 mm . 157,48"x314,96"	UNI EN ISO 10545-4	Modulo di rottura Modulus of rupture R average ≥ 35 N/mm2	≥ 45 N	≥ 50 N	Conforme Compliant	
	UNI EN ISO 10545-4	Sforzo di rottura Breaking strength h ≥ 7,5 mm; S > 1300 N	≥ 1300 N	≥ 9000 N	Conforme Compliant	
Resistenza all'abrasione profonda Deep abrasion resistance Résistance à l'abrasion profonde Tiefenverschleißbeständigkeit	UNI EN ISO 10545-6	≤ 175 mm³	≤ 175 mm³	≤ 175 mm³	Conforme Compliant	
Resistenza agli sbalzi termici Resistance to thermal shock Résistance aux écarts de température Temperaturwechselbeständigkeit	UNI EN ISO 10545-9	Resistente Resistant	Resistente Resistant	Resistente Resistant	Conforme Compliant	
Resistenza al gelo Frost resistance Résistance au gel Frostbeständigkeit	UNI EN ISO 10545-12	Resistente Resistant	Ingelivo Frost proof	Ingelivo Frost proof	Conforme Compliant	
Resistenza all'attacco chimico Chemical resistance Resistance a l'attaque chimique Beständigkeit gegen chemikalien	UNI EN ISO 10545-13	Detergenti ad uso domestico e additivi per uso piscina Household detergents and additives for swimming pools Détergents à usage domestique et additifs pour piscines Hausreinigungsmittel und Zusatzstoffe für Schwimmbäder	Valori dichiarati Declared values B minimo minimum	A	A	Conforme Compliant
		Resistenza all'attacco chimico Chemical resistance Resistance a l'attaque chimique Beständigkeit gegen chemikalien	Valori dichiarati Declared values B minimo minimum	A; LA; HA Honed/Natural Real Matt B; LB; HB 3D Texture Polished	A; LA; HA Honed/Natural Real Matt B; LB; HB 3D Texture Polished	Conforme Compliant
Resistenza alle macchie Stain resistance Resistance aux taches Fleckenbeständigkeit	UNI EN ISO 10545-14	Valori dichiarati Declared values	Classe 3-5	Classe 3-5	Conforme Compliant	
Resistenza dei colori alla luce Colour resistance to light exposure Résistance des couleurs à la lumière Farbechtheit unter Lichteinfluss	DIN 51094	Resistente Resistant	Resistente Resistant	Resistente Resistant	Conforme Compliant	
Reazione al fuoco Fire reaction Résistance au feu Feuerfestigkeit	UNI EN 13501-1	Resistente Resistant	Resistente Resistant	Resistente Resistant	Conforme Compliant	

* Valori dichiarati ottenuti da test di laboratorio. Possono subire variazioni in base al lotto produttivo.

Stated values are obtained from laboratory tests. They may vary depending on the production batch

Valeurs déclarées basées sur des essais en laboratoire. Peuvent subir des variations en fonction du lot de production

Die angegebenen Werte basieren auf Labortests. Es kann von Charge zu Charge zu Abweichungen kommen



Ceramics of Italy

AD: Marketing Dept.

02/2025

© Ceramica Fondovalle S.p.A.

È vietata la riproduzione, totale e parziale del catalogo in tutte le sue forme.

Reproduction of this printed catalogue totally or partially, is forbidden.

Ceramica Fondovalle si riserva di apportare, qualora lo ritenesse opportuno, eventuali modifiche di natura tecnica o formale ai dati riportati in questo strumento. I colori sono puramente indicativi.

Ceramica Fondovalle reserves the right, when it deems necessary, to make technical and formal changes to the data included herein. The colours are purely illustrative.

FOND(0)VALLE

Ceramica Fondovalle S.p.A.

Via Rio Piodo, 12
41053 Torre Maina, (MO) Italy
T. +39 0536 934211
F. +39 0536 934250
www.fondovalle.it

A company part of

ITALCER
GROUP
DESIGN SURFACES



**ITALCER - WINNER OF THE
2022 SUSTAINABILITY AWARD**



